



### Kosmetické podsvícené LED zrcátko

LED zvětšovací zrcátko s dotykovým podsvíceným senzorem. Teplota chromatičnosti 6500K. Výkon 8W.

### LED cosmetic mirror

LED cosmetic mirror magnifying with illuminated touch switch.

Náhradní díly / Spare parts

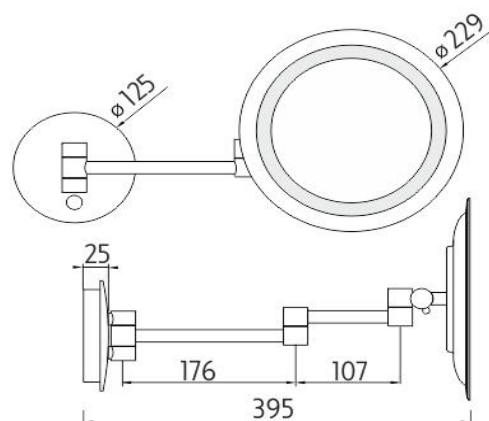

→ 400    ↑ 230    ↗ 230

montáž / installation :



montážní konzole / installation bracket :

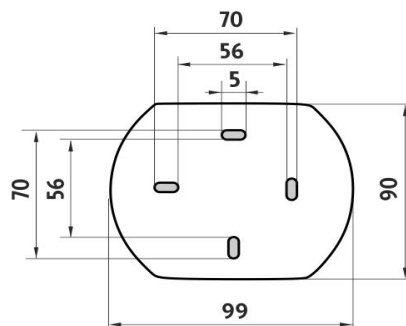

materiál - úprava (barva) / material - surface finish (colour) :

**Mosaz-Chrom**

**Brass-Chrome**



→ 250

↑ 330

↗ 130

EAN : 8595187111547



ROMVEL spol. s r. o.  
Dr. Milady Horákové 561/86a  
Liberec 7, 460 07  
Česká Republika / Czech Republic

T: (+420) 485 105 671  
T: (+420) 485 107 441  
F: (+420) 485 105 674  
E: nimco@nimco.cz



www.nimco.cz