

Smile SDC heating and district heating controller

SERVICE MANUAL





Contents

1	Software version	11
2	Safety instructions.....	11
2.1	Intended use	11
2.2	Requirements for start-up	11
2.2.1	Power supply.....	12
2.2.2	Connection conditions.....	12
2.2.3	Cable cross-sections.....	12
2.2.4	Maximum cable lengths	12
2.2.5	Cable installation.....	12
2.2.6	Grounding and zeroing.....	13
2.3	Hot-water temperature greater than 60 °C	13
2.4	Connection of accessory parts	13
2.5	Maintenance and cleaning.....	14
2.6	Safety precautions for EMC-compliant installation	15
3	Overview	20
4	Abbreviations	21
5	Operation	22
5.1	Display and operating elements	22
5.1.1	Display (basic display)	23
5.1.2	Operating elements.....	24
5.1.2.1	Input button (press / turn).....	24
5.1.2.2	"Daytime room temperature" button.....	24
5.1.2.3	"Night-time room temperature" button.....	25
5.1.2.4	"Daytime hot-water temperature" button.....	25
5.1.2.5	"Operating mode" button (basic display).....	26
5.1.2.6	"Switching time programs / Holiday programs" button.....	33
5.1.2.7	"System information" button	35
5.1.2.8	"Manual mode" / "Emission measurement" button	44
5.1.2.9	Access to the technician / OEM area	46

	5.1.2.10 Heating curve	47
5.2	Menu-selection level	48
5.2.1	"Time - Date" menu	54
5.2.2	"Timeprograms" menu	55
	5.2.2.1 Selection of the control circuit	56
	5.2.2.2 Selection of the program	56
	5.2.2.3 Selection of day of the week and cycle	56
	5.2.2.4 Programming switching times and cycle temperatures	57
5.2.3	"System Parameters" menu	71
	5.2.3.1 Language selection	72
	5.2.3.2 Time program	72
	5.2.3.3 Operating mode	74
	5.2.3.4 Parameter reset	76
	5.2.3.5 Complete reset	77
5.2.4	"DHW" menu	77
	5.2.4.1 Night-time hot-water temperature	78
	5.2.4.2 Legionella protection day	78
5.2.5	"Direct Heating Circuit" / "Mixed Heating Circuit 1" / "Mixed Heating Circuit 2" menu	78
	5.2.5.1 Reduced operation	79
	5.2.5.2 Heating system	80
5.3	Error messages	80
5.4	Parameter settings	81
5.4.1	"Hydraulics" menu (HYDRAULIC)	81
5.4.2	"System parameters" menu (SYSTEM)	85
5.4.3	"Hot-water circuit" menu (DHW)	89
5.4.4	"Direct heating circuit" menu (UNMIXED CIRC)	92
5.4.5	"Mixed heating circuit 1 / 2" (MIX.VALVE - 1 / MIX.VALVE - 2) menus	95
5.4.6	"Heat generator" menu (HEAT GENER.)	99
5.4.7	"District hot water" menu (DIST.HEATING)	103

5.4.8	"Return increase" menu (RETURN CONTR).....	105
5.4.9	"Solar" menu (SOLAR).....	106
5.4.10	"Solid" menu (SOLID FUEL).....	107
5.4.11	"Buffer" menu (BUFFER).....	108
5.4.12	"Total flow regulation" menu (MAIN SUPPLY).....	109
5.4.13	"Cascading" menu (CASCADE).....	110
5.4.14	"Data bus" menu (BUS).....	111
5.4.15	"Relay test" menu (RELAY TEST).....	111
5.4.16	"Error messages" menu (ALARM).....	112
5.4.17	"Error messages 2" menu (ALARM 2).....	113
5.4.18	"Service" menu (SERVICE).....	113
5.4.19	"Sensor calibration" menu (SENSOR ADJ.).....	114
6	Control Functions	115
6.1	Variable adjustment of the hydraulic parameters (variable inputs and outputs).....	115
6.1.1	Connection and settings table.....	116
6.2	Switching time program enabling.....	117
6.3	Suppressing the cycle temperature on time program level.....	118
6.4	Enabling "Separate Control Mode".....	118
6.5	Switching from SDC to DHC.....	119
6.6	Selection of hydraulic parameter presets.....	119
6.7	The variable inputs and outputs of device series SDC/DHC 43.....	119
6.8	General functions and their operation.....	120
6.8.1	Outside temperature sensing.....	120
6.8.1.1	Building type.....	120
6.8.2	Heating circuit outside temperature assignment.....	121
6.8.3	Outside temperature emergency operation value.....	121
6.8.4	Outside temperature disable.....	122
6.8.5	Climate zone.....	122
6.8.6	Design temperature.....	122
6.8.7	Summer switch-off.....	123

6.8.8	System frost protection	124
6.8.9	Pump forced operation.....	127
7	Hydraulic Components.....	128
7.1	Heat generator: Boiler	128
7.1.1	Heat generator start-up protection	128
7.1.2	Heat generator minimum temperature limit	129
7.1.3	Maximum temperature limit heat generator	130
7.1.4	Heating circuits minimum temperature limit.....	130
7.1.5	Heat generator sensor control mode	130
7.1.6	Minimum burner runtime	131
7.1.7	Switching: Multi-stage heat generator/Switching differential .	132
7.1.8	Operation for modulating burners	136
7.1.9	Modulation of P part (Xp)	137
7.1.10	Modulation of sample time Ta.....	137
7.1.11	Modulation of integral action time Tn.....	138
7.1.12	Modulation of runtime.....	138
7.1.13	Modulation of start time.....	138
7.1.14	Modulation of start power.....	138
7.1.15	OpenTherm	139
7.1.16	Use of boiler sensor 2	140
7.1.17	External heat generator cut-off	140
7.1.18	Heat generator forced discharge	141
7.1.19	Exhaust gas temperature monitoring.....	141
7.1.20	Burner counter mode	142
7.2	Heat generation, heat exchanger, district heating	143
7.2.1	On/Off operation of the district heating valve.....	144
7.2.2	Continuous heat exchanger valve control.....	145
7.2.3	District heating return temperature limit.....	146
7.2.4	Return temperature limit for hot-water loading	148
7.2.5	Hot-water pre-regulator with district heating systems.....	149
7.2.6	Mode of operation: Hot-water pre-control	150

7.2.7	Quick hot-water control	151
7.2.8	Mode of operation of hot-water control mode "external operation"	153
7.2.9	Conditional parallel operation for mixed heating circuits	154
7.2.10	Circulation pump control mode	154
7.2.11	Switch-off of district heating control	155
7.2.12	Return interval flushing	155
7.2.13	Heat meter for additional limitation according to the volume flow or thermal output	155
7.2.14	Charging pump (CHP).....	156
7.2.15	Primary pump	157
7.2.16	Boiler circuit pump.....	157
7.2.17	Return increase	158
	7.2.17.1 Bypass pump (RBP).....	159
	7.2.17.2 Return maintenance through controlled feed water addition	159
	7.2.17.3 Indirect return increase.....	160
7.3	Heating circuit	160
7.3.1	General heating circuit functions.....	160
	7.3.1.1 Heating curve	160
	7.3.1.2 Heating curve setting (heating curve)	161
	7.3.1.3 Reduced operation	163
	7.3.1.4 Heating system.....	163
	7.3.1.5 Heating circuit temperature limit.....	163
	7.3.1.6 Heating circuit temperature offset	164
	7.3.1.7 Heating circuit pump extended running time.....	164
	7.3.1.8 Screed function.....	164
7.3.2	Heating circuit constant temperature control	167
7.3.3	Fixed-value control.....	168
7.3.4	Consideration of the room temperature/room influence	168
	7.3.4.1 Heating circuit room connection	168
	7.3.4.2 Heating circuit room factor	169

7.3.4.3	Heating circuit room controller	170
7.3.4.4	Switch-on/switch-off optimisation	170
7.3.4.5	Room setpoint ramp	174
7.3.4.6	Heating limit function	174
7.3.4.7	Heating circuit room frost protection limit	176
7.3.4.8	Mixed heating circuits cooling switch-over	176
7.3.4.9	Heating circuit name	179
7.3.4.10	Room thermostat function (maximum room temperature limit)	180
7.3.5	Hot-water production	186
7.3.5.1	Hot-water tank loading (SLP)	186
7.3.5.2	Circulation pump (CIR.)	193
7.3.6	Solar/Solid fuel/Buffer	196
7.3.6.1	Solar function	196
7.3.6.2	Buffer tank function	199
7.3.6.3	Solid fuel function	212
7.3.7	Tank loading switch-over	213
7.3.8	Hydraulic buffer relief (HBR)	215
7.3.9	Easy enabling and disabling of a heating pump	216
7.3.10	Other system components	217
7.3.10.1	Global fault message input	217
7.3.10.2	Global fault message output	217
7.3.10.3	Timer	217
7.3.10.4	External switching modem	218
7.3.10.5	External information	219
7.3.10.6	Demand contact	219
7.3.11	Bus communication	221
7.3.11.1	Bus address of central device	221
7.3.11.2	Control functions via the data bus	222
7.3.11.3	Operation of wall devices	227
7.3.12	Cascading of heat generators in the bus system	233

7.3.12.1	General description of cascading of control devices	233
7.3.12.2	Function of the cascade parameters	235
7.3.12.3	Mode of operation of cascade control	236
7.3.13	Commissioning, maintenance and troubleshooting help	239
7.3.13.1	Automatic set function	239
7.3.13.2	Emission measurement (not for DHC 43)	240
7.3.13.3	Relay/function test	241
7.4	Error messages	245
7.4.1	Basic display/fault stack fault messages	250
7.4.1.1	Sensor calibration	251
7.4.1.2	Full controller reset	251
7.4.1.3	Controller time correction	251
8	Technical data	252
8.1	General	252
8.1.1	Installation recommendations	253
8.2	Sensor resistance values	253
8.2.1	NTC 20	253
8.2.2	PT 1000	254
8.3	Sensor measurement ranges	255
8.4	Digital inputs	256
9	Log	257
	Index	258

1 Software version

This documentation is valid for software version **V 3.2** of your control device. The software version is displayed after switch-on for approx. 8 s. If you are using an older software version, please contact your heating technician.

2 Safety instructions

2.1 Intended use

The SDC / DHC Smile family of controllers was designed for the sole purpose of regulating and controlling hot-water, heating and district heating systems (including hot-water production) that do not exceed a maximum flow temperature of 120 °C.

2.2 Requirements for start-up

ATTENTION

The heating system must be complete and filled with water so that the pumps do not run dry and the heating boiler is not damaged.

The control equipment must be installed in accordance with the installation instructions.

All electrical connections (voltage supply, burner, mixer motor, pumps, sensor wiring etc.) must be carried out by the technician in accordance with the applicable VDE regulations and correspond with the circuit diagrams.

If floor heating is connected, a limiting thermostat must also be installed in the flow line after the heating circuit pump. This switches off the pumps at excessive flow temperatures.

Before starting up the controller, have the heating technician check all requirements listed above.

NOTE The current time and date are already set at the factory and are backed up by a battery.

The time switch functions based on a basic program and the control functions are preset for common heating systems with low-temperature boilers.

2.2.1 Power supply

Do not disconnect the controller from the mains supply!

The battery for saving all individualised data is otherwise unnecessarily strained. The frost-protection function of the controller is deactivated.

2.2.2 Connection conditions

All electrical connection work may only be carried out by qualified personnel!

2.2.3 Cable cross-sections

1.5 mm² for all cables carrying 230 V (power supply, burner, pumps, actuator).

0.6 mm² for bus cables (recommended type J-Y(St)Y 2 x 0.6).

0.5 mm² for sensors, selectors and analog signal cables.

2.2.4 Maximum cable lengths

Sensor, selector and analog inputs

We recommend using cables no longer than 200 m. Longer connection lines could be used, but increase the risk of interference.

Relay outputs

Unlimited cable length.

Bus connections

Max. length of 100 m from the first bus subscriber to the last one (incl. wall modules).

2.2.5 Cable installation

Install cables for sensors apart from the cables carrying 230 V!
Branch boxes in the sensor cable must be avoided!

2.2.6 Grounding and zeroing

Local regulations on the connection of equipment must be observed!

2.3 Hot-water temperature greater than 60 °C

ATTENTION

Note that there is a danger of scalding at all hot-water draw-off points (kitchen, bathroom etc.) in the following cases. Add sufficient cold water in these cases.

Automatic anti-legionella mechanism

When the automatic anti-legionella mechanism is activated, the hot water is automatically heated to the anti-legionella temperature (65 °C at the factory) on the selected day and at the selected time to kill any legionella bacteria found in the hot-water tank.

Manual mode / Emission measurement

In the manual mode / emission measurement operating mode, the hot water is heated up to the highest possible boiler temperature, as the burner and all pumps are switched on and the mixer is opened fully. There is an acute danger of scalding at all connected hot-water draw-off points! Add sufficient cold water or switch off the hot-water loading pump (at the switch of the pump, if present). Heating and hot water are in unregulated continuous operation. This operating mode is for special use by the chimney sweep for emission measurement or if the controller is defective. The high hot-water temperatures can be prevented, however, by setting the boiler thermostat to a max. boiler temperature of approx. 60 °C.

2.4 Connection of accessory parts

WARNING

According to VDE 0730, a separator for each mains terminal is to be provided in the voltage supply to the control

equipment. Observe the local regulations regarding grounding and zeroing.

As soon as the mains voltage is applied to terminals 21, 22, 2, 6, 12 and 18, headers X3 and X4 can also carry mains voltage.

If the heating circuit and hot-water loading pumps do not have an On / Off switch, but manual switch-on and switch-off capability is still desired, the appropriate switches must be installed by the customer. All accessory parts (sensors, selectors etc.) are to be connected to the respective circuit diagram.

2.5 Maintenance and cleaning

The controller is maintenance-free. The device can be cleaned externally with a moist (not wet) cloth.

2.6 Safety precautions for EMC-compliant installation

Mains lines and sensor/data bus lines must be installed separate from each other. A minimum of 2 cm space must be present between the lines. It is permissible to cross lines.

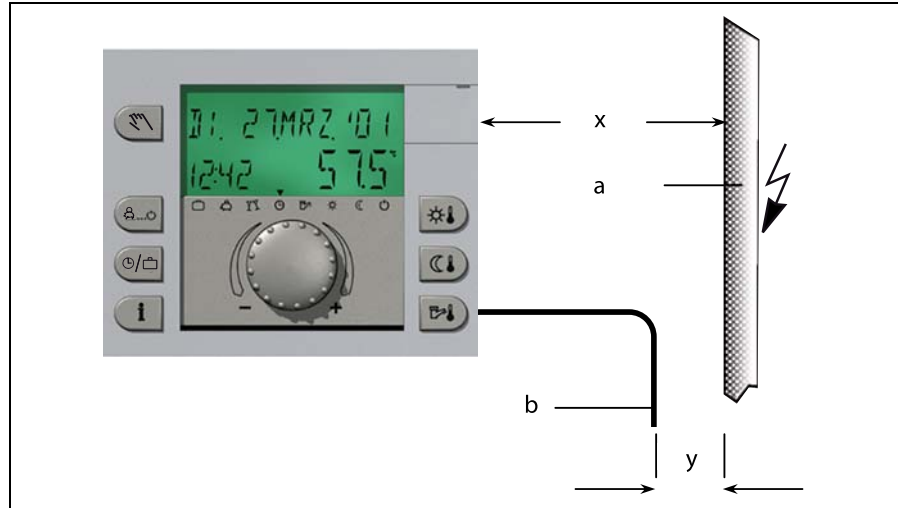

- | | | | |
|---|-----------------------|---|-------|
| a | Mains 230 V AC | x | 15 cm |
| b | Data bus line 12 V AC | y | 2 cm |

For control devices with their own mains connection, separate installation of mains and sensor/bus lines must absolutely be ensured. If cable ducts are used, they are to be provided with cut-off bridges.

When installing control or wall devices, a minimum spacing of 40 cm to other electrical equipment with electromagnetic emissions, e.g. relays, motors, transformers, dimmers, microwave ovens and televisions, audio speakers, computers, cordless telephones etc., is to be ensured.

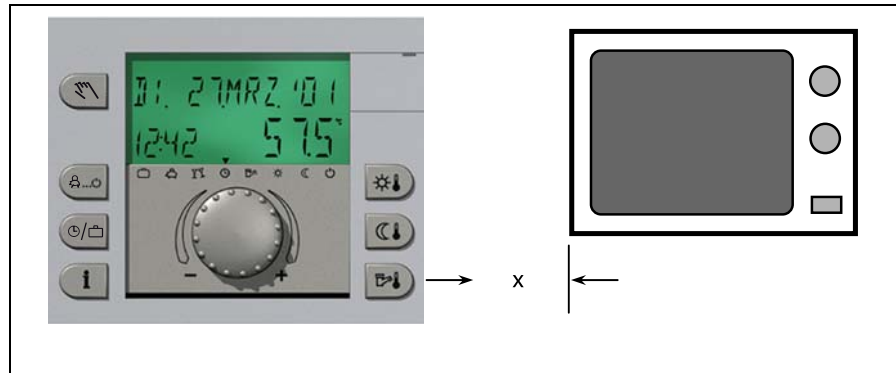

x 40 cm

A minimum spacing of 40 cm is to be ensured between wall devices and central devices. Multiple central devices in the data bus system can be mounted directly next to one another.

The mains connection of the heating system (boiler – panel – control equipment) must be designed as a separate circuit. Neither fluorescent lamps nor any machines which are potential sources of interference may be connected/connectable.

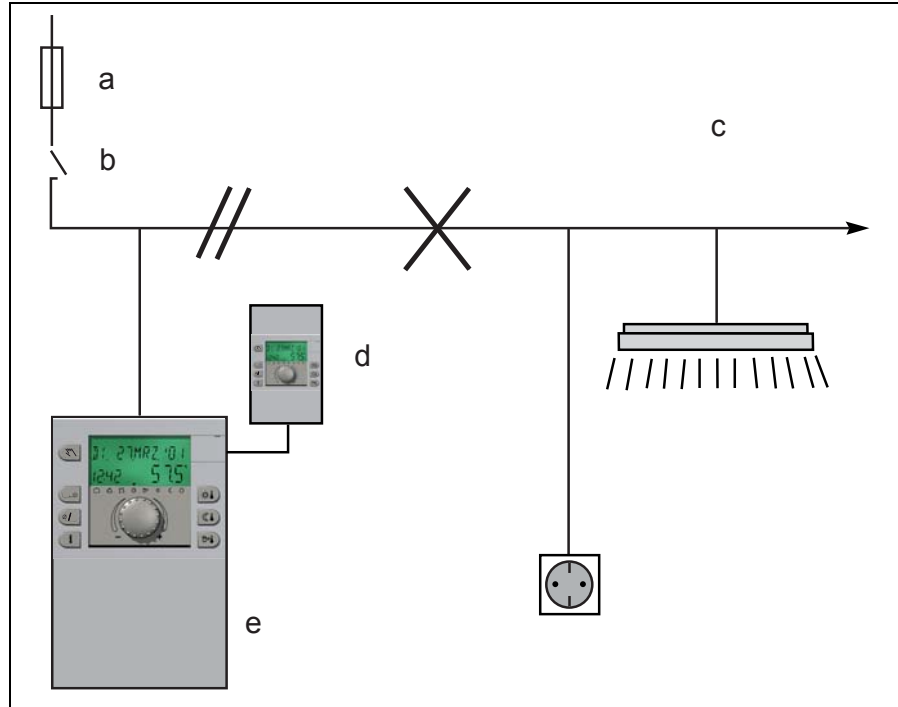

- a Safety fuse 16 A
- b Boiler room emergency switch
- c Connect boiler room lighting and electrical outlets to separate circuits only!
- d Wall devices
- e Heat generator

Shielded cables must be used for the data bus lines.

For a recommended layout, see 8 Technical data, pg. 252

The earth connection of the cable shielding must occur on one side at the protective conductor connection, e.g. at the cladding plate of the heat generator, protective conductor terminal etc. Multiple earth connections of a single cable are not permissible (buzzing loop).

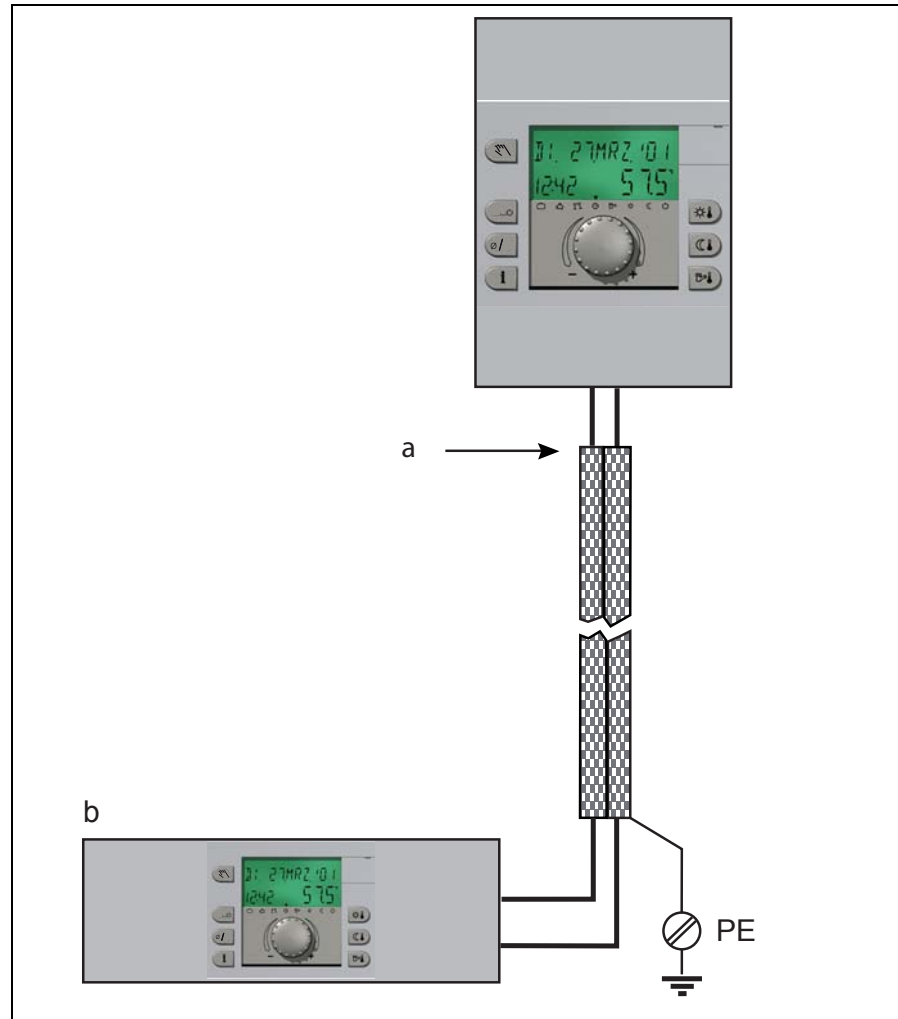

a No earth connection here!

b Central device

With star-topology data bus systems, double earth connections may not be made. The earth connection must be made on one side of the star!

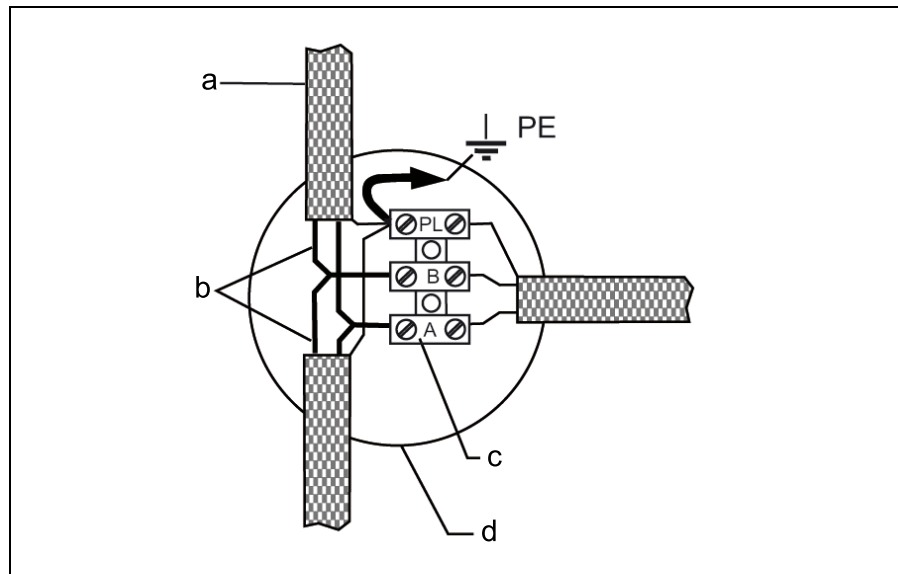

- | | | | |
|---|----------------------|---|------------------------|
| a | Shielding | b | Two-lead data bus line |
| c | Distributor terminal | d | Branch box |

The outside sensor may not be installed near transmitters or receivers (e.g. on garage walls near garage door opener receivers, amateur radio antennas, radio alarm systems or directly next to large transmission equipment etc.).

3 Overview

The modular SDC / DHC control device is available in an installable switch cabinet version and a surface-mounted wall version with the following equipment features:

Type	Number of output relays	Burner stage 2 or District heating valve CLOSED	Burner stage 1	Direct heating circuit Variable output 3	Mixed heating circuit 1	Mixed heating circuit 2	Tank loading pump	Variable output 2	Variable output 1
SDC 3-10	3	–	x	x	–	–	x	–	–
SDC 3-40	3	–	–	–	x	–	–	–	–
SDC 7-21 ¹⁾	7	x	x	x	x	–	x	–	–
SDC 9-21 ²⁾	7 + two variable relays	x	x	x	x	–	x	x	x
SDC 12-31 ³⁾	10 + two variable relays	x	x	x	x	x	x	x	x

¹⁾ DHC 43-1

²⁾ DHC 43-2

³⁾ DHC 43-3

4 Abbreviations

The following abbreviations are used in this documentation/in the display of the control device:

RED	Lowering operation	BS 2	Buffer sensor 2 (bottom)
OS	Outside sensor	BLP	Buffer loading pump
OS2	Outside sensor 2	RBP	Return bypass pump
FGS	Flue gas sensor	RP	Return pump
OT	Outside temperature	SD I	Switching differential I
BUS	System data bus	SD II	Switching differential II
OC1	Burner stage 1 operating hour counter	TS	Tank sensor
OC2	Burner stage 2 operating hour counter	TLP	Tank loading pump
DC	Direct heating circuit	SLS	Solar loading switch-over
DCP	Direct heating circuit pump	SLSS	Solar loading switch-over sensor
ECO	Switch-off operation	SFD	Solar forced dissipation
EHR	Electric heating rod	SLP	Solar loading pump
SFB	Solid fuel boiler sensor	STL	Stratified tank loading pump
SFR	Solid fuel buffer sensor	VO	Variable output (general)
FC	Fixed-value control	VO1	Variable output 1
SFP	Solid fuel pump	VO2	Variable output 2
PI	Pulse input	VI	Variable input (general)
BP	Boiler circuit pump	VI1	Variable input 1
CC	Constant control	VI2	Variable input 2
CRS	Collector return sensor	VI3	Variable input 3
CTBS	Collector tank/buffer sensor	FM1	Flow sensor of mixed heating circuit 1
CFS	Collector flow sensor	FM2	Flow sensor of mixed heating circuit 2
MM	Mixer motor	PHE	Parallel heat generator enable
MC	Mixed heating circuit	HG	Heat generator
MHP	Mixed heating circuit pump	HGS	Heat generator sensor
P1	Switching time program	WD	Wall device for room temperature sensing
P2	Switching time program	HW	Hot water
P3	Switching time program	CIR	Circulation pump
BS	Buffer sensor (top)	CHP	Charging pump

5 Operation

5.1 Display and operating elements

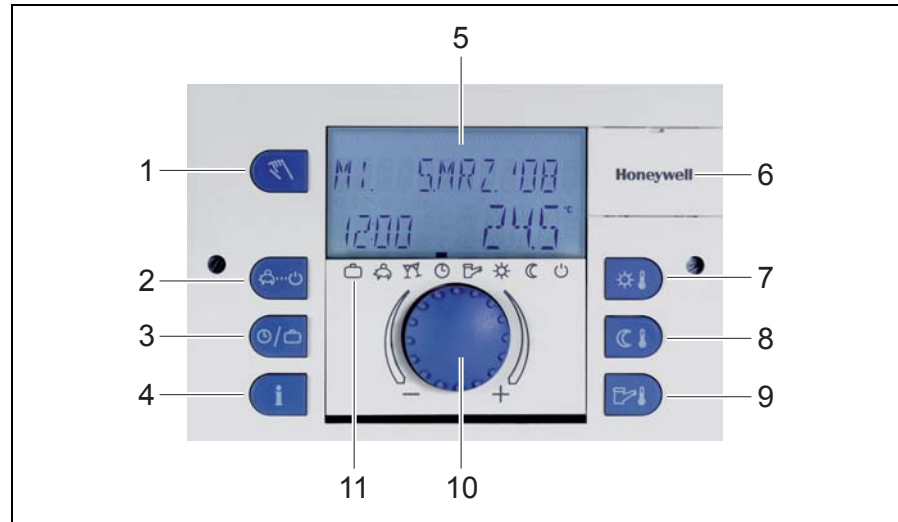

- 1 "Manual mode" / "Emission measurement" button (not on district heating controllers)
- 2 "Operating modes" button (basic display)
- 3 "Switching time programs" / "Holiday programs" button
- 4 "System information" button
- 5 Display
- 6 Cover clip for service socket
- 7 "Daytime room temperature" button
- 8 "Night-time room temperature" button
- 9 "Daytime hot-water temperature" button
- 10 Input button (press / turn)
- 11 Operating mode symbols (heating programs)

5.1.1 Display (basic display)

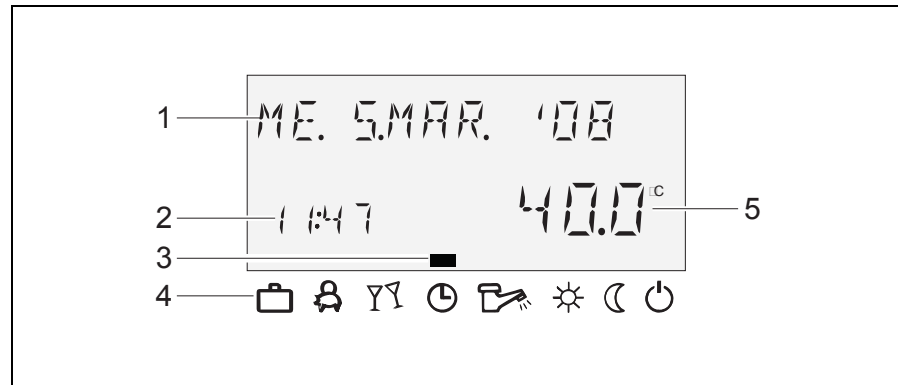

- | | | | |
|---|------------------------|---|----------------------------|
| 1 | Day of the week / Date | 4 | Operating mode symbols |
| 2 | Time | 5 | Heat generator temperature |
| 3 | Active operating mode | | |

The illumination of the display is switched on by pressing any button or using the input button and switches off automatically if no buttons are pressed for a longer period of time.

During start-up of the unit and after a power failure, a segment test with automatic fault diagnosis is carried out. The respective device type and the software version number then appear briefly.

The basic display that then appears shows the day of the week, the date, the time and the heat generator temperature in **automatic mode**. Different values appear in the basic display depending on the set operating mode (AUTOMATIC, PARTY etc.). Thus, for example, in the ABSENT operating mode, the indication ABSENT TIL appears instead of the date and the return date instead of the temperature. Active summer deactivation is indicated by a beach umbrella symbol , and active frost protection is indicated by a snowflake symbol .

5.1.2 Operating elements

5.1.2.1 Input button (press / turn)

By pressing once, you can:

- Confirm input / values

By pressing and holding (approx. 3 s), you can:

- Switch to the menu-selection level
- Move up one menu level

By turning the input button , you can:

- Change values (clockwise increases called-up values, anticlockwise decreases them)
- Navigate through menus

5.1.2.2 "Daytime room temperature" button

Sets the desired room temperature (room setpoint) in automatic mode during the heating cycles and in the PARTY and HEATING operating modes. In operating mode 1, the set value for all heating circuits is the same. In operating mode 2, the set value applies for the respective heating circuit. To set the operating mode, see 5.2.3.3 Operating mode, pg. 74.

Setting

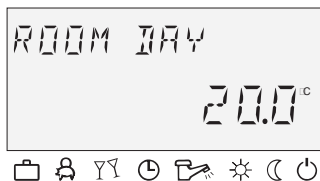

- ▶ Press button.
- ▶ Set flashing room temperature specification to the desired value by turning the input button .
- ▶ Confirm set value by pressing the button or the input button .

Alternative: Automatic acceptance of the value after the set information time (see 5.1.2.7 "System information" button, pg. 35).

Factory setting 20 °C





Setting range 5 ... 30 °C

5.1.2.3 "Night-time room temperature" button

Sets the lowered room temperature in automatic mode between the heating cycles and in the ABSENT and RED. HEATING operating modes.

In operating mode 1, the set value for all heating circuits is the same. In operating mode 2, the set value applies for the respective heating circuit. To set the operating mode, see 5.2.3.3 Operating mode, pg. 74.

Setting

- ▶ Press  button.
- ▶ Set flashing room temperature specification to the desired value by turning the input button .
- ▶ Confirm set value by pressing the  button or the input button .



Alternative: Automatic acceptance of the value after the set information time (see 5.1.2.7 "System information" button, pg. 35).





Factory setting 16 °C

Setting range 5 ... 30 °C

5.1.2.4 "Daytime hot-water temperature" button

Sets the daytime hot-water temperature during the hot-water operational-readiness times in automatic mode and in the PARTY and HEATING operating modes. This set value also applies for exclusively hot-water operation (manual summer operation).

Setting

- ▶ Press  button.
- ▶ Set flashing hot-water temperature to the desired value by turning the input button .
- ▶ Confirm set value by pressing the  button or the input button .

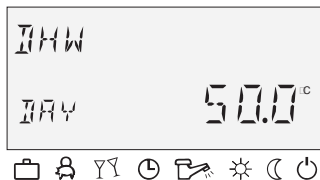

Alternative: Automatic acceptance of the value after the set information time (see 5.1.2.7 "System information" button, pg. 35).

Factory setting 50 °C

Setting range

5 °C (hot-water economy temperature) ... Maximum hot-water heater temperature limit (service setting)

One-time hot-water circuit loading

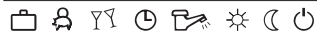
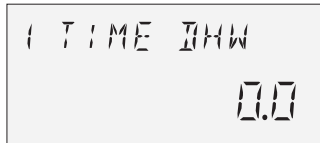



Pressing and holding (approx. 3 s) the button brings you to the reload function, where the reload time can be set in minutes. With a reload time of 0 minutes, loading is started once and the hot-water tank is loaded to the daytime setpoint. The time for this superimposed hot-water circuit loading can be set between 0 and 240 minutes. The current week program is superimposed here.

5.1.2.5 "Operating mode" button (basic display)





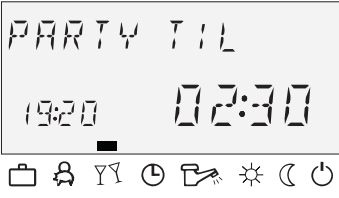
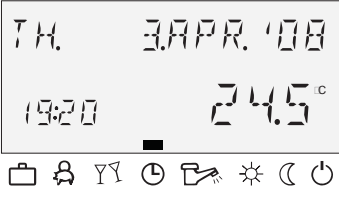
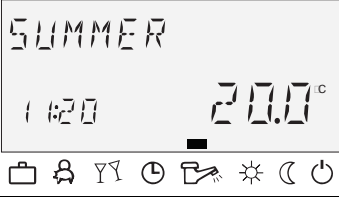

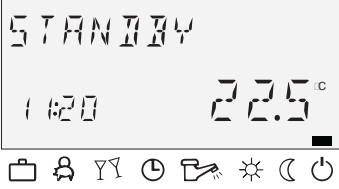

Sets the operating mode and returns to the basic display from every operating level.

Overview of the operating modes

Symbol	Operating mode	Display	Setting
	ABSENT		P1 (P2, P3)*, return date
	PARTY		P1 (P2, P3)*, party end time
	AUTOMATIC		P1 (P2, P3)*
	SUMMER		P1(P2, P3)*
	HEATING		
	RED. HEATING		
	STANDBY		

* P2 and P3 only after enabling, see "System Parameters" menu, parameter 2 = P1 to P3

The selected operating mode appears in plain text, whereby a marking at the bottom edge of the display points to the respective operating mode symbol at the same time. In operating mode 1, the set value for all heating circuits is the same. In operating mode 2, the set value applies for the respective heating circuit. To set the operating mode, see 5.2.3.3 Operating mode, pg. 74.

- Setting**
- ▶ Press  button.
 - ▶ Select operating mode by turning the input button . The marking is located above the corresponding operating mode symbol.
 - ▶ Confirm set operating mode by pressing the  button or the input button .
 - ▶ With short-term operating modes (ABSENT, PARTY), set the desired value by turning the input button  and confirm with the  button or the input button .

Alternative: Automatic acceptance of the value after the set information time (see 5.1.2.7 "System information" button, pg. 35).

Return to the basic display Press the  button for approx. 3 s to return to the basic display from any operating level.

NOTE Holiday mode is set via the "Switching time programs / Holiday programs" button (see 5.1.2.6 "Switching time programs / Holiday programs" button, pg. 33).

5.1.2.5.1 Absence mode (short-term program)





With the ABSENT operating mode, heating operation is temporarily deactivated and protected from frost during brief absences. During the absence, all heating circuits are adjusted to the specified lowered room temperature. Once the set time expires, the heating circuits automatically return to the operating mode that was active before the switch to the absence operation. Short-term programs such as PARTY or ABSENT are skipped here.

Setting See 5.1.2.5 "Operating mode" button (basic display) , pg. 26

Application Short absence while heating operation is active.

Cancellation An active absence program can be cancelled in case of early return.

- ▶ Press  button.
- ▶ Turn input button  and switch to automatic operation. The active absence program has been cancelled.

Factory setting P1 as from activation

Setting range P1 (P2, P3) / 0.5 to 24 h to the current time

P1 (P2, P3)

Program-controlled resumption of heating operation. After activation of the absence program, heating operation is interrupted until the following switch-on time of the current automatic program P1 (or P2 or P3, if enabled).

0,5 ... 24 h

The set value is added on to the current time and represents the return time. When the absence program is called up again, the last set value is saved and suggested as the initial value.

Display An active absence program appears in the basic display with information on the return time.

5.1.2.5.2 Party mode (short-term program)





Party mode causes one-time intermediate heating of all heating circuits up to a specified point in time and bridges an upcoming or already active absence cycle totally or partially. Once the set time expires, the heating circuits automatically return to the operating mode that was active before the party program. Short-term programs such as ABSENT or PARTY are skipped here.

Setting See 5.1.2.5 "Operating mode" button (basic display) , pg. 26

Application One-time extension of heating operation or intermediate heating during lowering operation outside the schedule.

Cancellation An active party program can be cancelled early.

- ▶ Press  button.
- ▶ Turn input button  and switch to automatic mode.
The active party program has been cancelled.

Factory setting P1 as from activation

Setting range P1 (P2, P3) / 0.5 to 24 h to the current time P1

P1 (P2, P3)

Program-controlled resumption of heating operation. After activation of the party program, heating operation is continued until the following switch-on time of the current automatic program P1 (or P2 or P3, if enabled)

0,5 ... 24 h

The set value is added on to the current time and represents the end of the party time. When the party program is called up again, the last set value is saved and suggested as the initial value.

Display An active party program appears in the basic display with information on the party end time.

5.1.2.5.3 Automatic mode

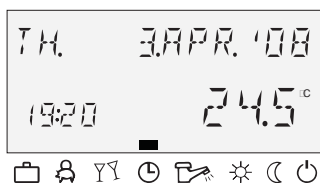

In automatic operation, max. three time programs with different heating operation times are available. They are called up during start-up as factory-set and unlosable default programs P1, P2 or P3 and can, if necessary, be overwritten with their own switching times in the "Timeprograms" menu (see 5.2.2 "Timeprograms" menu, pg. 55).

NOTE Default programs P2 and P3 cannot be selected until the PROGRAM = P1 to P3 parameter is enabled in the "System Parameters" menu. Without enabling, only program P1 is active.

Setting See 5.1.2.5 "Operating mode" button (basic display) , pg. 26

Disabling / enabling default program P2 to P3

Disabling

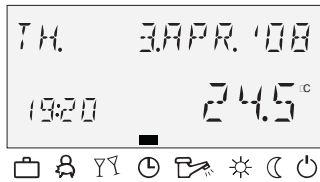

"System Parameters" menu, program parameter = P1. All heating circuits and the hot-water circuit solely refer to the default / individually programmed switching times in the program P1 parameter. Program P1 does not appear in the display in this operating mode (see 5.2.2 "Timeprograms" menu, pg. 55 and 5.2.3.2 Time program, pg. 72).

Enabling

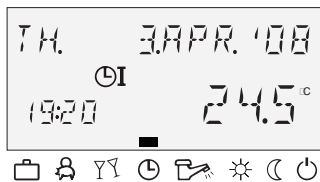

"System Parameters" menu, program parameter = P1 to P3 (see 5.2.2 "Timeprograms" menu, pg. 55 and 5.2.3.2 Time program, pg. 72).

Display

An active automatic program appears in the basic display with the current date and time. If default programs P2 and P3 were enabled, the corresponding symbol, , or , is also displayed depending on the selected program. The symbols are only displayed with the time program P1 to P3 active.

5.1.2.5.4 Manual summer operation (excluding heating operation)



With manual summer operation, only the hot-water circuit remains operation and controls the heat generator temperature based on the specified hot-water temperature and the specified hot-water switching time program. Heating operation is stopped, and protection from frost is provided. This feature is only available when control mode is set to 1.

Setting

See 5.1.2.5 "Operating mode" button (basic display) , pg. 26

Disabling / enabling default programs P2 to P3

Disabling



"System Parameters" menu, program parameter = P1. All heating circuits and the hot-water circuit solely refer to the default / individually programmed switching times in the time program = P1 parameter. Program P1 does not appear in the display in this operating mode (see 5.2.2.1 Selection of the control circuit, pg. 56 and 5.2.3.2 Time program, pg. 72).

**Display****Enabling**

"System Parameters" menu, program parameter = P1 to P3 (see 5.2.2.1 Selection of the control circuit, pg. 56 and 5.2.3.2 Time program, pg. 72).

Manual summer operation appears in the basic display with the information SUMMER. If default programs P2 and P3 were enabled, the corresponding symbol, , or , is also displayed depending on the selected program. The symbols are only displayed with the time program P1 to P3 active.

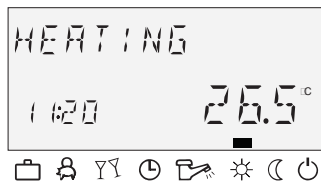
5.1.2.5.5 Continuous heating operation**NOTE**

The HEATING operating mode ensures continuous heating operation without time limitations based on the specified daytime room temperature. Hot-water production occurs continuously based on the specified daytime hot-water temperature.

The HEATING operating mode remains active until another operating mode is activated.

Display

Activated continuous heating operation appears in the basic display with the information HEATING.

5.1.2.5.6 Continuous lowering operation

The RED. HEATING operating mode causes continuously reduced heating operation based on the specified lowered room temperature. On the heating circuit levels, the reduced operating mode ECO (frost-protected deactivation mode) or RED (lowering mode) is set accordingly. The minimum temperature limit of the respective heating circuit must be taken into account.

See the "Direct Circuit" or "Mixed Heating Circuit 1" / "Mixed Heating Circuit 2" menu, reduced parameter = reduced operation and 12 parameter = minimum temperature limit.

Hot-water production occurs continuously based on the specified hot-water economy temperature (see "DHW" menu, hot water parameter = hot water at night).

NOTE The RED. HEATING operating mode remains active until another operating mode is activated.

Display Activated continuous lowering operation appears in the basic display with the information RED. HEATING.



In standby mode, the entire system is switched off and protected from frost (all frost-protection functions active).

Hot-water production is disabled and protected from frost. At storage temperatures below 5 °C, a reload to up to 8 °C takes place.

Application Total deactivation of heating and hot water with full building protection.

NOTE The heat generator and hot-water production remain in operation in case of external demand or demand by other heating circuits on the bus network. The heating circuit pumps are switched on briefly every day (pump anti-blocking protection).

The standby mode remains active until another operating mode is activated.

Display Activated continuous standby mode appears in the basic display with the information STANDBY.

5.1.2.6 "Switching time programs / Holiday programs" button



Using this button, you can create individualised switching time programs for heating and hot-water operation and set holiday mode.









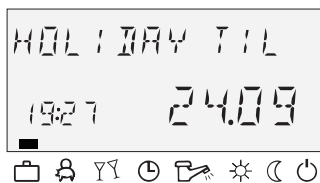

See 5.1.2.6.1 Holiday mode, pg. 34 and 5.2.2 "Timeprograms" menu, pg. 55.

5.1.2.6.1 Holiday mode

In holiday mode, the heating circuits can be switched off and protected from frost or operated based on the settings for the RED. HEATING operating mode for the duration of the holiday based on the presetting ("Direct circuit" or "Mixed heating circuit 1" / "Mixed heating circuit 2" menu, parameter 25 = holiday operating mode).

Setting



- ▶ Press  button.
The menu-selection level Switching time programs / Holiday programs appears in the display.
- ▶ Turn input button  to the left.
HOLIDAY appears in the display.
- ▶ Press input button .
HOLIDAY 01 appears in the display.
- ▶ Press input button .
The year flashes in the display.
- ▶ Set year with the input button .
- ▶ Press input button .
The day on which the holiday is to begin flashes in the display.
- ▶ Set the day the holiday will begin with the input button .
- ▶ Press input button .
TIL - - appears in the display.
- ▶ Set the day you will return from holiday with the input button .
- ▶ Press input button .
The desired holiday timeframe is saved.

You can now enter additional holiday timeframes (up to 15 holiday blocks).

Application Longer absence while heating operation is active.

Control during holidays	<p>At outside temperatures below the frost-protection limit (see 5.2.3 "System Parameters" menu, pg. 71) the heating circuits are controlled as follows:</p> <ul style="list-style-type: none"> • Without wall devices: Based on a lowered room temperature specification of 3 °C. • With wall devices: Based on the room frost-protection limit of the respective heating circuit of 10 °C (see "Direct Heating Circuit" or "Mixed Heating Circuit 1", "Mixed heating circuit 2" menu, parameter 08 = room frost-protection limit).
Cancellation	<p>An active holiday program can be cancelled in case of early return.</p> <p>▶ Press and hold the  button for approx. 3 seconds until the following appears in the display: "Holiday off".</p>
Factory setting	Current date
Setting range	Current date... (current date + 250 days)
Display	An active holiday program appears in the basic display with information on the return date.

5.1.2.7 "System information" button

Calls up system information, such as temperatures and counter data.

The information on the outside temperature appears first after the button is pressed. Turning the input button causes the system temperatures and the counter and consumption states and operating states of the connected system components to appear. Pressing the input button causes the respective setpoint values to appear.

Exceptions	Collector flow temperature:	No setpoint
	Solar tank temperature:	No setpoint
	Outside temperature:	Averaged value

NOTE The displayed information (see the following example) is independent of the installed or enabled system components and control circuits.

Operating overview

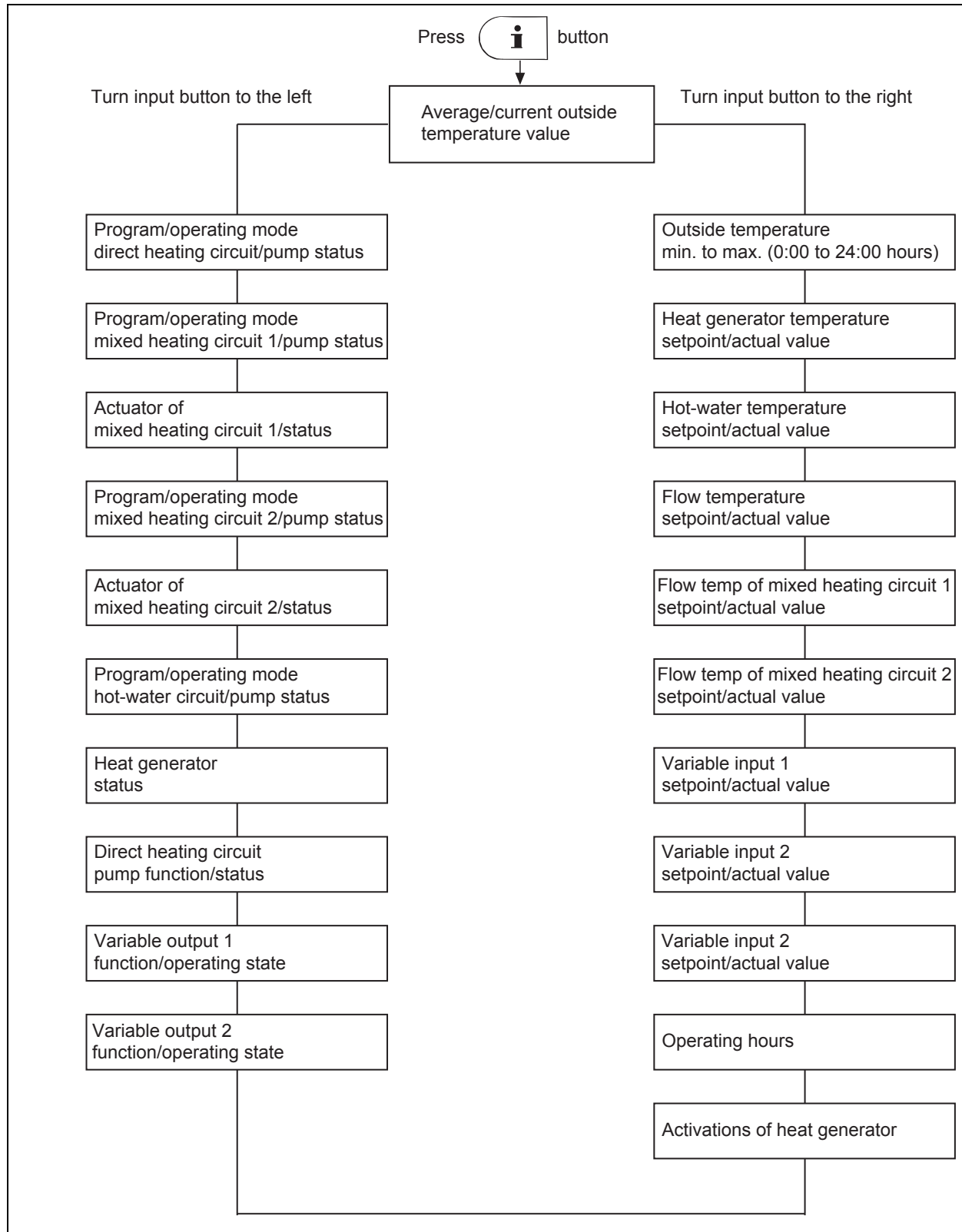

Setting time for automatic return If the button is pressed and held for approx. 3 s, the INFO TIME parameter appears.



With this parameter, the time it takes for automatic return to the basic display can be specified.

Setting range OFF No return. The last selected information display continuously remains in the basic display until the next change.

1 ... 10 min Automatic return from the information level after the specified time (in 0.5 minute increments).

Factory setting OFF

5.1.2.7.1 Temperature displays

Information	Display	Condition	Remarks
Outside temperature (1)	Determined value/Current value		
Outside temperature (1)	Min./max. value (0:00 to 24:00 hours)	Outside sensor connected and no fault message	
Outside temperature (2)	Determined value/Current value	Variable input configured as OS2	Connection OS2 to variable input V11, V12 or V13
Outside temperature (2)	Min./max. value (0:00 to 24:00 hours)	OS2 connected, no fault message	
EM-SET (energy management setpoint)	"EM-SET"		Highest hot-water setpoint and highest heating circuit setpoint in the system
Heat generator temperature (1)	Setpoint/Actual value	Heat generator specified	Code 1 only appears if BS2 is present
Heat generator temperature (2)	Setpoint/Actual value	Variable input configured as BS2	Connection BS2 to variable input V11, V12 or V13

Information	Display	Condition	Remarks
Return temperature	Setpoint/Actual value	Return sensor connected and one of the functions for return increase is active	Connection of return sensor to associated variable input 1 or 2, VI can no longer be called up
Flow sensor of district heating valve VF1	Setpoint/Actual value		With district heating controllers
Return sensor of district heating valve VFB	Setpoint/Actual value		With district heating controllers
External heat generator disable	Disabled mode ON/OFF	External heat generator disable (VI1-VI3) specified	External contact to variable input VI1, VI2 or VI3
Flue gas temperature	Limit signal value/Actual value	Variable input configured as AGF	Connection only to variable input VI1
Water heater temperature (1)	Setpoint/Actual value	If hot-water circuit is present	Code 1 only appears if SF2 is present
Water heater temperature (2)	Setpoint/Actual value	Variable input configured as SF2	Connection to variable input VI1, VI2 or VI3
Water heater temperature controller	Load condition ON/OFF	Thermostat mode	Thermostat instead of sensor (SF1 only)
Demand via switching contact (VI1)	Demand ON/OFF	VI configured as demand contact	External contact to variable input VI1, VI2 or VI3
Demand via switching contact (VI2)	Demand ON/OFF	VI configured as demand contact	External contact to variable input VI1, VI2 or VI3
Demand via switching contact (VI3)	Demand ON/OFF	VI configured as demand contact	External contact to variable input VI1, VI2 or VI3
Mixed heating circuit 1 flow temperature	Setpoint/Actual value	Mixed heating circuit 1 specified	
Mixed heating circuit 1 return temperature	Actual value	Return temperature with return maximum limit	

Information	Display	Condition	Remarks
Mixed heating circuit 2 flow temperature	Setpoint/Actual value	Mixed heating circuit 2 specified	
Mixed heating circuit 2 return temperature	Actual value	Return temperature with return maximum limit	
Direct heating circuit room temperature	Setpoint/Actual value	Direct heating circuit specified	Setpoint inquiry without room temperature sensing: Current room setpoint of direct heating circuit
Mixed heating circuit 1 room temperature	Setpoint/Actual value	Mixed heating circuit 1 specified	Setpoint inquiry without room temperature sensing: Current room setpoint of mixer heating circuit 1
Mixed heating circuit 2 room temperature	Setpoint/Actual value	Mixed heating circuit 2 specified	Setpoint inquiry without room temperature sensing: Current room setpoint of mixed heating circuit 2
Direct heating circuit thermostat function	DC THERMOSTAT	Thermostat function specified	OFF = temperature limit exceeded
Mixed heating circuit 1 thermostat function	MC1 THERMOSTAT	Thermostat function specified	OFF = temperature limit exceeded
Mixed heating circuit 2 thermostat function	MC2 THERMOSTAT	Thermostat function specified	OFF = temperature limit exceeded
Solid fuel boiler temperature	Actual value	VO1/2 configured as solid fuel loading pump	Connection of FSKF to associated variable input 1 or 2, VI can no longer be called up
Solid fuel boiler buffer temperature	Actual value		Solid fuel loading pump at variable output, corresponds to KSPF or FPF, depending on configuration

Information	Display	Condition	Remarks
Buffer tank temperature at top	Setpoint/Actual value	VO1/2 configured as buffer tank loading pump	Connection of PF1 to associated variable input 1 or 2, VI can no longer be called up
Buffer tank temperature at bottom	Setpoint/Actual value	VO1/2 configured as buffer tank loading pump	Connection of PF2 to variable input VI1, VI2 or VI3
Solar collector flow temperature	Actual value	VO1/2 configured as solar tank loading pump	Special sensor
Solar tank temperature	Actual value	VO1/2 configured as solar tank loading pump	
Solar collector return temperature	Actual value	VO1/2 configured as solar tank loading pump	Connection of KRLF to variable input VI1, VI2 or VI3
Solar tank switch-over temperature	Actual value		Solar loading valve activated

5.1.2.7.2 Operating states

An operating state inquiry occurs after the information menu is called up by turning the input button anti-clockwise. The following displays appear only under the specified conditions and may not be available (depends on device version).

Information	Display	Condition	Remarks
Direct heating circuit operating status		Direct heating circuit specified	Heating program: Holiday, Absent Til, Party Til, Auto, Summer, Heating, Red. Heating, Standby Switching time program: P1 (P2, P3) control mode: Day, RED, ECO
Mixed heating circuit 1 operating status		Mixed heating circuit 1 specified	Heating program: Holiday, Absent Til, Party Til, Auto, Summer, Heating, Red. Heating, Standby Switching time program: P1 (P2, P3) control mode: Day, RED, ECO

Information	Display	Condition	Remarks
MC1 actuator operating status	MIX. VALVE-1 STOP	Mixed heating circuit 1 specified	Mixed heating circuit 1 opens, closes or does not move
Mixed heating circuit 2 operating status	AUTO-P1 ECO ME2 ON	Mixed heating circuit 2 specified	Heating program: Holiday, Absent Til, Party Til, Auto, Summer, Heating, Red. Heating, Standby Switching time program: P1 (P2, P3) control mode: Day, RED, ECO
MC2 actuator operating status	MIX. VALVE-2 OPEN/STOP/CLOS	Mixed heating circuit 2 specified	Mixed heating circuit 2 opens, closes or does not move
District heating valve operating status	OPEN/STOP/CLOS	District heating valve opens, closes or does not move	With district heating controllers
Heat generator operating status (st. 1)	HEAT GENER. ON/OFF	Heat generator specified	Information on the switching state of the multi-stage heat generator
Heat generator operating status (st. 2)	HEAT GENER. ST-2 ON/OFF	Multi-stage heat generator specified	Information on the switching state of the second stage of the heat generator
Operating status of modulating heat generator	MODULATION 57% 60%	Modulating burner specified	If a single-stage modulating heat generator is set, display of actual value and setpoint occurs in %
Hot-water circuit operating status	AUTO-P1 ECO HW ON	Hot-water circuit specified	Hot-water program: Holiday, Absent Til, Party Til, Auto, Summer, Heating, Red. Heating, Standby Switching time program: P1 (P2, P3) control mode: Day, RED, ECO

Information	Display	Condition	Remarks
Function and status of direct heating circuit pump	<pre> OUTPUT DEP EO ON/OFF </pre>	Outputs specified based on function	Solar (SOP), circulation (CIR), electric heating rod (ELH), feeder (CHP), boiler circuit (KKP1, KKP2), fault message (SMA), return (RLP), buffer (PLP), solid fuel (FSP), heating circuit (HKP), constant (KP), timer (CLOCK)
Function and status of variable output 1	<pre> OUTPUT VO-1 SOP ON/OFF </pre>	Outputs specified based on function	Solar (SOP), circulation (CIR), electric heating rod (ELH), feeder (CHP), boiler circuit (KKP1, KKP2), fault message (SMA), return (RLP), buffer (PLP), solid fuel (FSP), heating circuit (HKP), constant (KP), timer (CLOCK)
Function and status of variable output 2	<pre> OUTPUT VO-2 CIR ON/OFF </pre>	Outputs specified based on function	Solar (SOP), circulation (CIR), electric heating rod (ELH), feeder (CHP), boiler circuit (KKP1, KKP2), fault message (SMA), return (RLP), buffer (PLP), solid fuel (FSP), heating circuit (HKP), constant (KP), timer (CLOCK)
District heating valve volume flow		Heat generator specified	With district heating controllers
District heating valve capacity		Heat generator specified	With district heating controllers
Heat generator (1) start-ups	<pre> NR OF STARTS 1275 </pre>	Heat generator specified	Information on the number of heat generator switch-ons (burner start-ups) of the multi-stage heat generator.
Operating hours of heat generator (1)	<pre> OPER. HOURS 280 </pre>	Heat generator specified	Information on the number of heat generator operating hours of the multi-stage heat generator.

Information	Display	Condition	Remarks
Heat generator switch-ons stage 2	NR OF STARTS 530 ST-2	Multi-stage heat generator specified	Information on the number of heat generator switch-ons (burner start-ups) of the second stage.
Heat generator operating hours stage 2	OPER. HOURS 200 ST-2	Multi-stage heat generator specified	Information on the number of heat generator operating hours of the second stage.
Test temperature for measurement purposes	INFO TEMP 50°	KVT sensor connected and VI configured.	Controller-independent test temperature, sensor connection to variable input VI1, VI2 or VI3
Operating status of ext. switching modem	MODEM RED	VI configured as switching modem	Control modes based on the switching state of the modem: AUTO (automatic) STBY (standby), HEAT (continuous heating), RED (continuously reduced).
Solar heating capacity	HEAT POWER 50L	VO1/2 configured as solar tank loading pump	Solar loading pump at variable output
Solar heat balance	HEAT CONS. 50L	VO1/2 configured as solar tank loading pump	Solar loading pump at variable output
Switch-ons Solar loading pump	NR OF STARTS 50L	VO1/2 configured as solar tank loading pump	Solar loading pump at variable output
Operating hours Solar loading pump	OPER. HOURS 50L	VO1/2 configured as solar tank loading pump	Solar loading pump at variable output

5.1.2.8 "Manual mode" / "Emission measurement" button

5.1.2.8.1 Manual mode



If this button is pressed and held longer than 5 s in the basic display, the controller is switched to manual mode. In this operating mode, the required heat generator temperature is specified manually with the input button according to the respective heating need.

A controller set to manual mode has no effect in heat circuit expansion.



The heat generator setpoint is set between the minimum and maximum heat generator temperatures and appears flashing at the bottom left-hand side. The current heat generator temperature appears statically on the right-hand side in the basic display. The set switching differential corresponds to the value of automatic control and is symmetrical to the set value.

Application Controller malfunctions (emergency operation), errors

NOTE The maximum heat generator temperature limit is paramount to the heat generator switching differential and stops the heat generator in case of exceedance.

With control devices operated purely as a heating circuit expansion, the setting of the temperature has no effect.

The last value to which the control device adjusted the heat generator temperature appears as a recommendation.

Cancellation Press  button or  button, to return to the last selected operating mode.

5.1.2.8.2 Emission measurement (not with district heating controllers)

ATTENTION

Emission measurements may only be carried out by the chimney sweep.

Pressing the  button controls the heat generator for a duration of 20 min based on the set maximum temperature limit. The remaining time is displayed and counted down.



With two-stage heat generators, both stages are in operation (measurement at nominal output).

Function The heat generator is adjusted to the maximum heat generator temperature. All heating circuits and the hot-water production adjust their setpoint to the respective maximum temperature.

ATTENTION

There is a danger of scalding by hot water, as the hot-water temperature can exceed the set setpoint temperature.



Application Emission measurement by the chimney sweep.

Cancellation Emission measurement can be cancelled at any time with the  or  button.

5.1.2.9 Access to the technician / OEM area

Entering a technician or OEM code enables additional setting options in the parameter menu. The technician code is: 11000
For access to the OEM area, please ask your field-service contact partner.

Procedure:

- ▶ Press the  and  buttons simultaneously. The first number of the 4-digit code flashes.
- ▶ Set the first code number by turning the input button.
- ▶ Press the input button. The second number flashes.
- ▶ Enter all remaining code numbers as described in Steps 2 and 3. After entering the last code number, the controller is enabled for the respective area (technician or OEM).
- ▶ Press and hold the rotary button longer than 3 seconds. You reach the menu-selection level and can enter / modify parameters.

Pressing the  button jumps back to the previous selection.

Pressing the  button, pressing and holding the input button longer than 3 seconds or waiting until the set info time expires causes a jump back to the basic display.

5.1.2.10 Heating curve

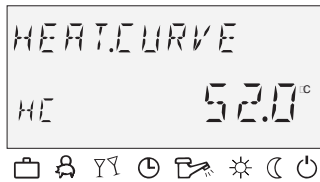

Determines the heating curve for the heating circuits.







The heating curve describes the relationship of the flow temperature change to the outside temperature change. With a larger heating surface, such as with floor heaters, the heating curve has a less extreme slope than with a smaller heating surface (e.g. radiators).

The set value refers to the lowest outside temperature used for heat demand calculation.

▲ ATTENTION

This parameter must be set by the technician and should no longer be changed.

Setting

- ▶ Press and hold input button  for 3 s.
- ▶ Turn the input button  to select the desired heating circuit (HC, MC-1 or MC-2) and confirm it by pressing the input button . The design temperature (system) appears at the bottom right-hand side of the display.
- ▶ Press input button . The slope of the heating curve appears at the bottom left-hand side of the display.
- ▶ Set the flashing heating curve value by turning the input button  (design temperature also flashes and is changed automatically depending on the slope of the heating curve).
- ▶ Confirm by pressing the input button .

Alternative: Automatic acceptance of the value after the set information time (see 5.1.2.7 "System information" button, pg. 35).

- ▶ Press  button to return to the basic display.

Setting range 0,2 ... 3,5

Factory setting	Direct heating circuit (HC)	1,5
	=	
	Mixed heating circuit 1 (MC-1)	1
=		
Mixed heating circuit 2 (MC-2)	1	
=		

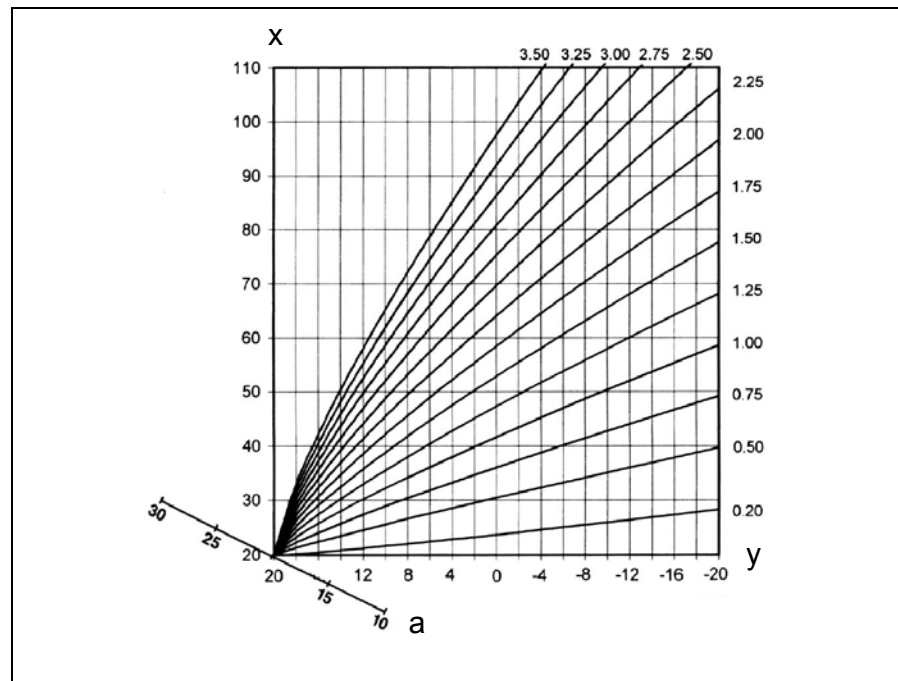

- x Boiler / flow temperature [°C]
- y Outside temperature [°C]
- a T_{room} [°C]

5.2 Menu-selection level

The control device contains a menu-selection level that is structured differently, depending on the respective device version.

- Access**
- ▶ Press and hold input button for approx. 3 seconds. The menu selection always begins with the TIME – DATE menu.
 - ▶ Turn input button to select additional menus.
 - ▶ Press input button to confirm the selected menu.

Parameter	0	1	2	3	4	5	6	7	8	9
Programming		Time	Year	Day - Month	Switch-over					
Configuration		Hydraulic schematic	Hot-water loading pump output	Mixed heating circuit 1 output	Mixed heating circuit 2 output	Direct heating circuit pump output	Variable output 1	Variable output 2	Variable input 1	Variable input 2
		Language selection	Time program	Operating mode	Summer/Heat limit	System frost protection	Demand contact module for variable input 1	Demand contact module for variable input 2	Demand contact module for variable input 3	Climate zone
		Hot water at night	Legionella protection day	Legionella protection time	Legionella protection temperature	Transducer for hot-water circuit	Max. temperature limit for hot-water circuit	Hot-water circuit control mode	Tank discharge protection	Temperature offset of heat generator during hot-water circuit loading
Direct heating circuit	Heating curve slope	Reduced operation	Heating system	Room connection	Room factor			Heating limit	Room frost protection limit	Room thermostat function
Mixed heating circuit 1/2	Heating curve slope	Reduced operation	Heating system	Room connection	Room factor			Heating limit	Room frost protection limit	Room thermostat function
Heat generator		Design	Start-up protection	Minimum temperature limit	Maximum temperature limit		Sensor control mode	Minimum burner runtime	Burner switching differential I	Burner switching differential II
District heating		Offset	Maximum flow temperature setpoint limit	District heating valve minimum travel	Secondary flow boost	Adjustment time	Runtime of district heating valve 1	Runtime of district heating valve 2	Max. return temperature setpoint	Starting point of flexible district heating return temperature
Return increase		Return temperature setpoint	Switch-off differential	Follow-up time of pump						
Solar		Switch-on differential	Switch-off differential	Solar loading pump minimum runtime	Buffer maximum temperature limit	Heat generator cycle disable	Control mode	Heat generator cycle disable	Priority parallel switch-over	Heat balance
Solid fuel		Min. temperature	Max. temperature	Switch-on differential	Switch-off differential	Heat generator cycle disable				
Buffer		Min. temperature	Max. temperature	Boiler temperature offset	Buffer switching differential	Forced discharge	Switch-on differential extension	Follow-up switch-off differential	Buffer start-up protection	Buffer discharge protection
Total flow control		Regulation	Regulation	Regulation						
Cascading		Switching differential	Connection delay	Switch-off delay	Switch-over capacity of stage sequence	Stage reversal	Guidance stage	Peak-load stage	Switch-over of base load with grouping	Quick hot-water connection
Data bus		Central device address	Direct heating circuit bus authorisation	Mixed heating circuit 1 bus authorisation	Mixed heating circuit 2 bus authorisation					
Relay test		Heat generator test	Direct heating circuit pump test	Mixed heating circuit pump 1 test	Mixer motor 1 test	Mixed heating circuit 2 flow sensor	Mixer motor 2 test	Tank loading pump test	Variable output 1 test	Variable output 2 test
Fault messages 1/2		Fault message 1	Fault message 2	Fault message 3	Fault message 4	Fault message 5	Fault message 6	Fault message 7	Fault message 8	Fault message 9
Sensor calibration		Outside sensor	Heat generator sensor	Hot-water sensor	Mixed heating circuit 1 flow sensor	Mixed heating circuit 2 flow sensor	Collector sensor	Buffer sensor of collector	Sensor of variable input 1	Sensor of variable input 2

Parameter	10	11	12	13	14	15	16	17	18	19
Programming	Date									
Configuration	Hydraulics	Variable input 3 Indirect return increase via mixed heating circuit	Anti-blocking function	Logical fault messages	Automatic set function	Locking code for heating technician	Type code		Cycle temperature enable	Frost protection mode
	System parameter	Building type Automatic exit time	Circulation pump switching time program	Circulation pump economy interval pause	Economy interval cycle		Circulation pump	Behaviour of heat generator during extended running time		
Configuration (heating circuits, control paths)	Hot water	Switching differential of hot-water circuit Hot-water loading pump extended running time	Circulation pump switching time program	Circulation pump economy interval pause	Economy interval cycle		Circulation pump	Behaviour of heat generator during extended running time		
	Direct heating circuit	Assignment of outside sensor	Minimum temperature limit	Maximum temperature limit	Temperature offset of heating circuit	Follow-up time of pump				
	Mixed heating circuit 1/2	Assignment of outside sensor	Minimum temperature limit	Maximum temperature limit	Temperature offset of heating circuit	Follow-up time of pump	Screed function	Return maximum temperature limit	P-part Xp	Sample time Ta
	Heat generator	Connection delay stage II Max. return temperature setpoint during hot-water circuit	Boiler start-up discharge stage II	Flow time of boiler circuit pump or parallel heat generator enable	Boiler circuit pump extended running time	Charging pump extended running time	Flue gas temperature monitoring	Flue gas temperature monitoring	Flue gas temperature limit	Modulation of proportional part Xp
	District heating	Reset heat balance	District heating valve return limit	Calibration of thermal output	Max. thermal output	Max. volume flow				
	Return increase	Volume flow	Density of medium	Heat capacity of medium		Solar loading switch-over test cycle		Switch-over temperature		
	Solar	Buffer loading pump extended running time								
	Solid fuel									
	Buffer	Buffer control mode								
	Total flow control									
Cascading										
Data bus										
Relay test	System									
Service functions	Fault messages 1/2	Fault message 10	Fault message 11	Fault message 12	Fault message 13	Fault message 14	Fault message 15	Fault message 16	Fault message 17	Fault message 18
	Sensor calibration	Sensor of variable input 3	Direct heating circuit room sensor	Mixed heating circuit 1 room sensor	Mixed heating circuit 2 room sensor					

Parameter	20	21	22	23	24	25	26	27	28	29
Programming	Date									
Configuration	Hydraulics									
	System parameter	Adjustment of the real time clock (RTC)		Locking code for operating level		Cooling switch-on temperature			Fault memory 2	Characteristic curve for emergency operation without outside sensor
Configuration (heating circuits, control paths)	Hot water								Switch-on delay for electrical water heater	Offset setpoint for electrical water heater
	Direct heating circuit				Room control C-factor	Holiday control mode	Room setpoint ramp			
	Mixed heating circuit 1/2	I-part Tn	Actuator runtime	Actuator end position function	Room control C-factor	Holiday control mode	Room setpoint ramp		Cooling temperature of mixed heating circuit	
	Heat generator		Modulation of adjustment time Tn	Modulation of runtime	Modulation of start time	Outside temperature disable	Base load offset	Heating circuit minimum temperature limit	Heating circuit minimum temperature limit switching differential	Heat generator forced discharge
	District heating									
	Return increase									
	Solar									
	Solid fuel									
	Buffer									
	Total flow control									
Service functions	Cascading									
	Data bus									
	Relay test									
	Fault messages 1/2	Fault message 20	Reset fault messages							
Sensor calibration										

Parameter	30	31	32	33	34	35	36	37	38	39
Programming	Date									
Configuration	Hydraulics									
	System parameter			Selection SDC/DHC		Parameter reset				
	Hot water									
	Direct heating circuit									
	Mixed heating circuit 1/2									Hot-water circuit pre-control spread
	Heat generator	OEM maximum limit	Full-load control		Heating capacity limit	Hot-water capacity limit		Burner counter mode	Inverse outside temperature disable	Fixed delay (cascade)
	District heating									
	Return increase									
	Solar									
	Solid fuel									
Buffer										
Total flow control										
Cascading										
Data bus										
Relay test										
Fault messages 1/2										
Sensor calibration										
Service functions										

	Parameter	40	41	42	43	44	45	46	47	Heating circuit name
Programming	Date									
	Hydraulics									
Configuration	System parameter									
	Hot water									
Configuration (heating circuits, control paths)	Direct heating circuit		Switch-on optimisation	Min. pre-heat time	Max. pre-heat time	Min. jump back temperature	Without room sensor	Pre-heat time at 0°C	Lowering ramp	Heating circuit name
	Mixed heating circuit 1/2	Offset valve position of hot-water circuit pre-control	Switch-on optimisation	Min. pre-heat time	Max. pre-heat time	Min. jump back temperature	Without room sensor	Pre-heat time at 0°C	Lowering ramp	Heating circuit name
	Heat generator	Resetting of stage 2 burner start-up and operating hour counters								
	District heating									
	Return increase									
	Solar									
	Solid fuel									
	Buffer									
	Total flow control									
	Cascading									
	Data bus									
	Service functions	Relay test		User	Heating technician	OEM				
Fault messages 1/2										
Sensor calibration										

5.2.1 "Time - Date" menu

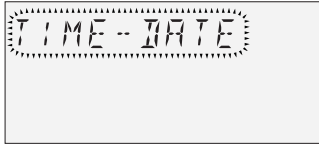

The following current calendar values can be specified in this menu:





- Time
- Year
- Day - Month
- Time change mode (summer / winter time)

NOTE All listed daytime values are set at the factory and generally do not need to be updated.

An internal, pre-programmed calendar ensures automatic time change on the annually recurring summer / winter time switchover dates. If necessary, the automatic time change can be deactivated. The current weekday, Mo to Su is determined from the calendar date and does not need to be set.

Application Corrections for rare fault cases

Access See 5.2 Menu-selection level, pg. 48

- Setting**
- ▶ Turn input button  and select the "Time - Date" menu.
 - ▶ Turn input button  and select the desired calendar value (time, year, day - month, change).
 - ▶ Press input button  and change the corresponding value by turning the input button .
 - ▶ Press input button  to confirm the set value.
 - ▶ Turn input button  to select and change additional calendar values.

Returning Returning to the basic display takes place by pressing the  button or automatically after the set information time (see 5.1.2.7 "System information" button, pg. 35).

5.2.2 "Timeprograms" menu

Individualised switching time programs for heating and hot-water operation can be created in this menu. Here, the factory-set default programs P1 (and, if enabled, P2 and P3 as well) of each heating circuit and the hot-water circuit are overwritten by individualised switching times and temperature specifications. This is especially advantageous if correspondingly adapted heating programs are to be created in case of periodically recurring assignments with different assignment times (e.g. shift work). Max. three heating cycles, each with a switch-on and switch-off time, are available for each day of the week for programming switching times. Each heating cycle can also be combined with a freely-selectable temperature specification.

NOTE The default programs are not lost when overwritten by individually created programs. Individualised programs, however, are deleted when default programs are reloaded and must be recreated. For this reason, individualised switch-on / switch-off times and temperature specifications should always be entered in the tables provided for this purpose (see 9 Log, pg. 257).

Access Press  button.

Returning Returning to the basic display takes place by pressing the  button or automatically after the set information time (see 5.1.2.7 "System information" button, pg. 35).

5.2.2.1 Selection of the control circuit

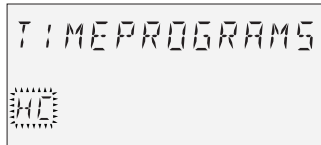

After accessing the "Timeprograms" menu, the desired control circuits can be selected with the input button in the following sequence:

- Direct heating circuit (HC)
 - Mixed heating circuit 1 (MC-1)
 - Mixed heating circuit 2 (MC-2)
 - Hot-water circuit (DHW)
- ▶ Press input button to access the selected circuit.

5.2.2.2 Selection of the program

If the switching time programs P2 and P3 have been enabled (see "System Parameter" menu, program parameter = P1 to P3), the program selection appears.

If switching time programs P2 and P3 are disabled, program selection is automatically skipped (see "System Parameters" menu, program parameter = P1).

5.2.2.3 Selection of day of the week and cycle

Once the program is selected, the first cycle of the first day of the week (MO 1) and the relevant section in the top time bar flash. The other cycles are selected by turning the input button and confirmed by pressing the input button .

5.2.2.4 Programming switching times and cycle temperatures

5.2.2.4.1 Switch-on time

The switch-on time is the start of heating or, with enabled switch-on optimisation, the start of assignment.

After selecting the day of the week and the corresponding cycle, the respective switch-on time appears flashing and can be set with the input button . The time bar in the top part of the display provides an overview of all programmed cycles between 0:00 and 24:00 hours on the selected day of the week.

NOTE The switch-on time cannot be set below the switch-off time of a previous cycle or below 0:00 hours of the selected day of the week.

If the switch-on time is changed, the corresponding time bar display is adjusted to the left-hand side.

If the switch-on time is made equal to the switch-off time, the corresponding cycle is deleted. A subsequent cycle is automatically shifted to the position of the deleted cycle upon acceptance.

With subsequent insertion of a cycle that has been bumped up, the corresponding day of the week must be reprogrammed.

A flashing switch-on time is accepted by pressing the input button .

5.2.2.4.2 Switch-off time

The switch-off time is the end of heating or, with enabled switch-off optimisation, the end of assignment.

Once the switch-on time is accepted, the associated switch-off time appears flashing and can be changed with the input button . The time bar in the top part of the display provides an overview of all programmed cycles between 0:00 and 24:00 hours on the selected day of the week.

NOTE The switch-off time cannot be set higher than the switch-on time of a subsequent cycle.

If the switch-on time is changed, the corresponding time bar display is adjusted to the right-hand side.

If the switch-off time is made equal to the switch-on time, the corresponding cycle is deleted. A subsequent cycle is automatically shifted to the position of the deleted cycle upon acceptance.

With subsequent insertion of a cycle that has been bumped up, the corresponding day of the week must be reprogrammed.

A flashing switch-off time is accepted by pressing the input button .

5.2.2.4.3 Cycle temperature

Once the switch-off time is accepted, the associated cycle temperature appears flashing and can be changed immediately with the input button . With heating circuits, the displayed cycle temperature is always based on the desired room temperature; with the hot-water circuit, it is based on the desired normal hot-water temperature in the selected cycle.

A flashing cycle temperature is accepted by pressing the input button .

At the same time, the last called-up cycle appears flashing so that it may be monitored; additional cycles can then be selected directly and edited in the same way in the order: switch-on time, switch-off time, cycle temperature.

Switching time programming (programs P2 and P3 disabled)

Upon accessing the menu-selection level, the "Timeprograms" menu always appears first.

Enabling of programs P2 and P3 in the "System Parameters" menu (see 5.2 Menu-selection level, pg. 48).

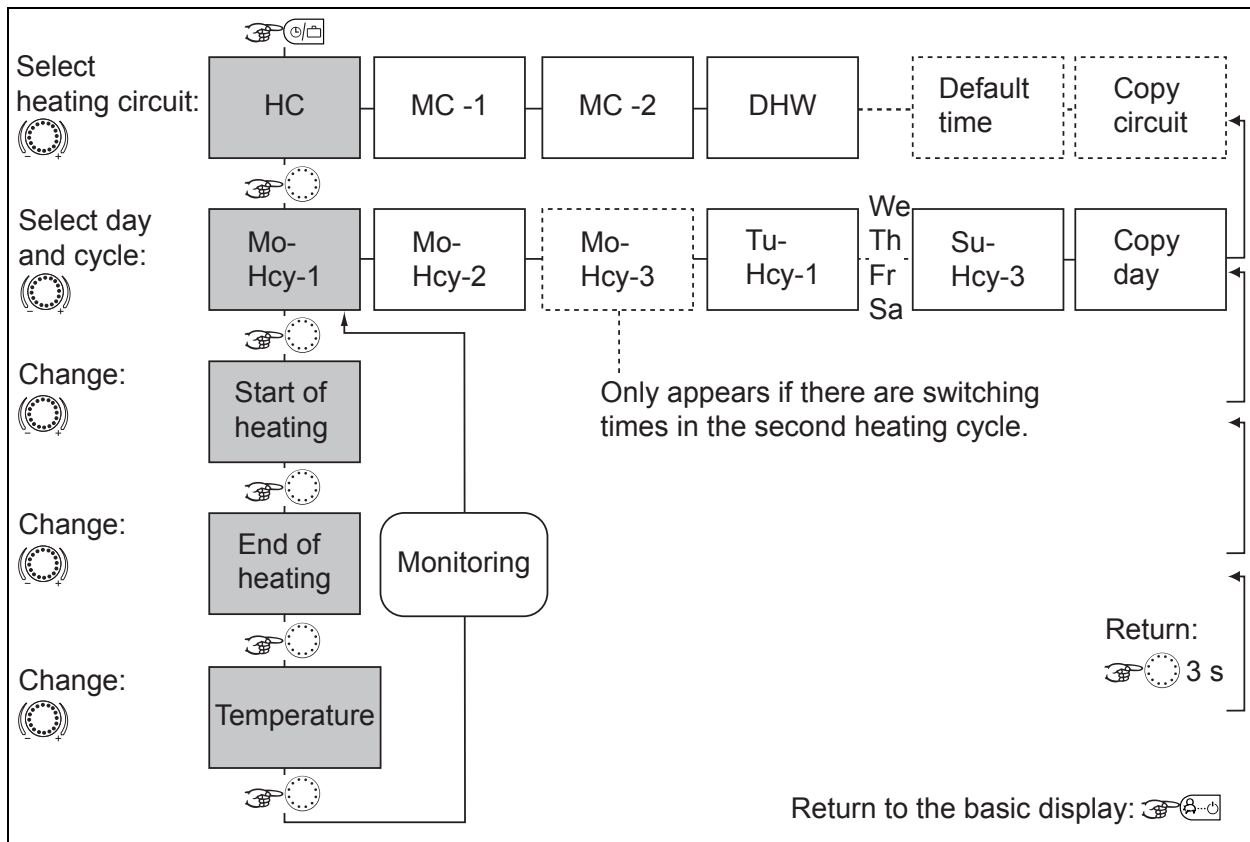

- HC Direct heating circuit
- MC-1 Mixed heating circuit 1
- MC-2 Mixed heating circuit 2
- DHW Hot-water heating circuit
- Hcy Heating cycle

Default switching time program (P1) for heating and hot water

Uniform, continuous heating and hot-water operation on all days of the week

Default program P1			
Heating circuit	Day	Heating operation	
		from	to
Heat generator heating circuit	Mo to Su	6:00	22:00
Hot-water circuit	Mo to Su	5:00	22:00
Mixed heating circuit 1 / 2	Mo to Su	6:00	22:00

Switching time programming (program P2 and P3 enabled)

Upon accessing the menu-selection level, the "Timeprograms" menu always appears first. Enabling of programs P2 and P3 in

the "System Parameters" menu (see 5.2 Menu-selection level, pg. 48).

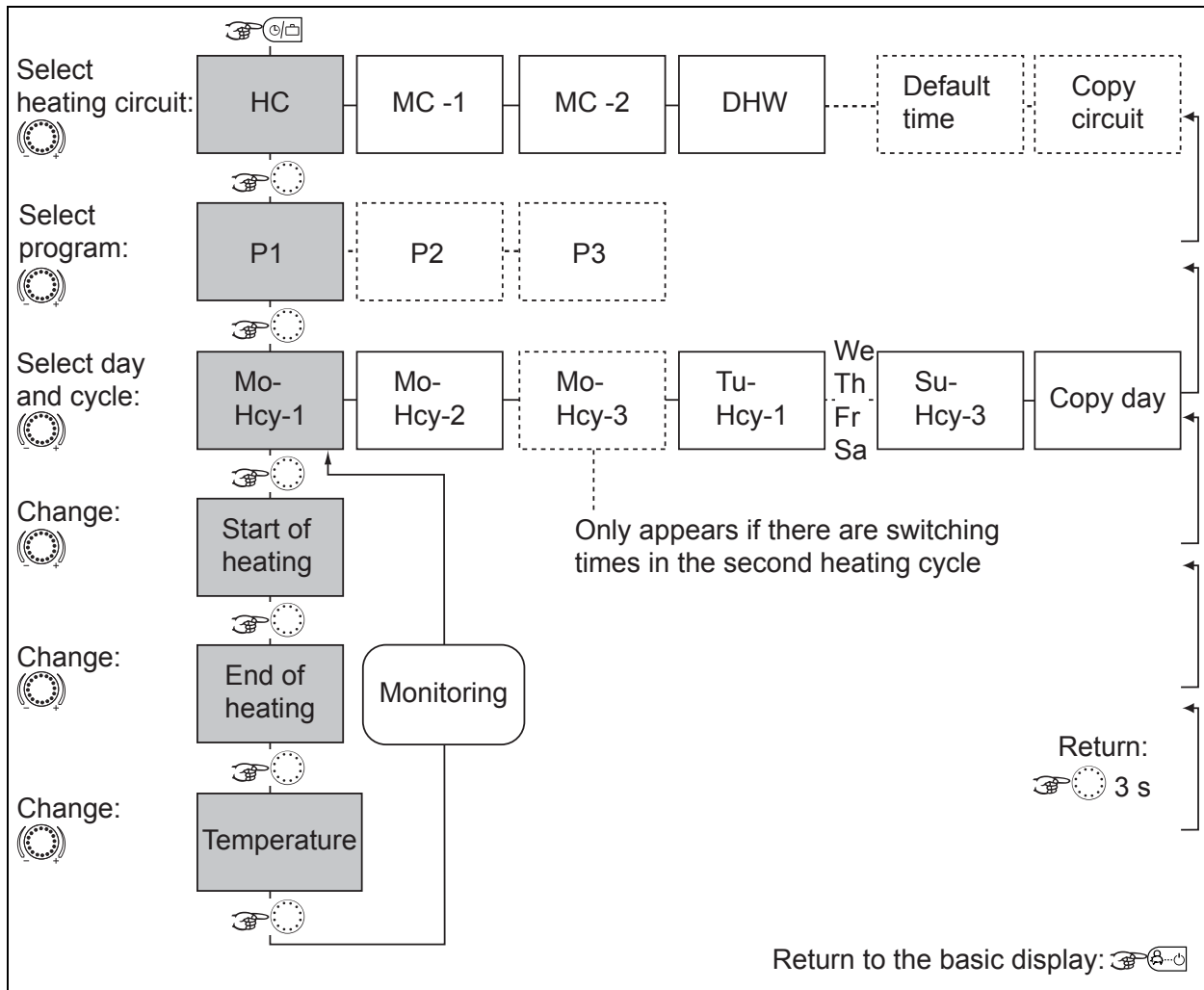

- HC Direct heating circuit
- MC-1 Mixed heating circuit 1
- MC-2 Mixed heating circuit 2
- DHW Hot-water heating circuit
- Hcy Heating cycle

Default program P1			
Heating circuit	Day	Heating operation	
		from	to
Heat generator heating circuit	Mo to Su	6:00	22:00
Hot-water circuit	Mo to Su	5:00	22:00
Mixed heating circuit 1 / 2	Mo to Su	6:00	22:00

Default program P2					
Heating circuit	Day	Heating operation			
		from	to	from	to
Boiler heating circuit	Mo to Th	6:00	8:00	16:00	22:00
	Fr	6:00	8:00	13:00	22:00
	Sa to Su	6:00	22:00		
Hot-water circuit	Mo to Th	5:00	8:00	15:30	22:00
	Fr	5:00	8:00	12:30	22:00
	Sa to Su	6:00	23:00		
Mixed heating circuit 1 / 2	Mo to Th	6:00	8:00	16:00	22:00
	Fr	6:00	8:00	13:00	22:00
	Sa to Su	7:00	23:00		

Default program P3			
Heating circuit	Day	Heating operation	
		from	to
Heat generator heating circuit	Mo to Fr	7:00	18:00
	Sa to Su	Reduced	
Hot-water circuit	Mo to Su	6:00	18:00
	Sa to Su	Reduced	
Mixed heating circuit 1 / 2	Mo to Su	7:00	18:00
	Sa to Su	Reduced	



5.2.2.4.3.1 Copying switching time programs (days)



Block programming enables the switching times and cycle temperatures of any day of the week to be copied

- 1 – To any days within the week (Mo, Tu, We, ..., Su)
- 2 – To all weekdays (Mo to Fr)
- 3 – To the weekend (Sa to Su)
- 4 – To the entire week (Mo to Su)

Calling up the copy function (days)

See flowcharts on pg. 65

- Source day**
- ▶ Press input button  to confirm the copy function.
 - ▶ Turn input button  to select the source day (MO to SU) to be copied.
The respective automatic program P1 (P2, P3) of the source day is copied in the display with the time switch symbol and the program index.

- Target day**
- ▶ Press input button  to confirm the source day.
The source day appears flashing.
 - ▶ Turn input button  to select the following setting values and confirm by pressing the input button  :
 - The following target days (Mo to Su) individually
 - All days of the week (1 to 7) as a week block
 - All weekdays (1 to 5) as a weekday block
 - The weekend days (6 to 7) as a weekend block

Acceptance is confirmed by acknowledging DAY COPY OK.

After acknowledgement, the following target days appear one after another automatically with each additional press of the input button  and can be skipped and accepted if necessary.

Pressing the  button causes an immediate return to the basic display.



NOTE Only complete days with all cycles and temperature specifications and the respective program can be copied.

5.2.2.4.3.2 Copying switching time programs (heating circuits)

Block programming also enables the copying of all switching times and temperature specifications of a heating circuit to another heating circuit.

Calling up the copy function (heating circuits)

See flowcharts on pg. 65

- Source circuit**
- ▶ Press input button  to confirm the copy function.
 - ▶ Turn input button  to select the source circuit to be copied (HC, MC-1, MC-2, DHW).
If automatic program P1, P2 or P3 (see "System Parameter" menu, PROGRAM parameter = P1 to P3) was enabled, the desired switching time program P1, P2 or P3 of the source circuit can be selected. If not enabled, program selection is skipped.

- Target circuit**
- ▶ Press input button , to confirm the source circuit.
Based on the same chart, the desired target circuit and, if enabled, the desired program can be selected and accepted.

Acceptance is confirmed by acknowledging COPY OK. The copy function is then called up again to copy additional circuits, if necessary.

NOTE Heating circuits cannot be copied to hot-water circuits or the reverse due to the different temperature specifications. If a heating circuit (HC, MC-1, MC-2) is selected as the source circuit, the hot-water circuit (DHW) switches off as the target circuit.

A hot-water circuit as the source circuit is also the target circuit. In this case, only switching time programs P1 to P3 are copied among one another.

Pressing the  button causes an immediate return to the basic display.

Block programming

The copy function enables a source day to be copied to any target days or to all days of the week (week programming). All cycles of the source day are copied. Individual heating cycles cannot be copied.

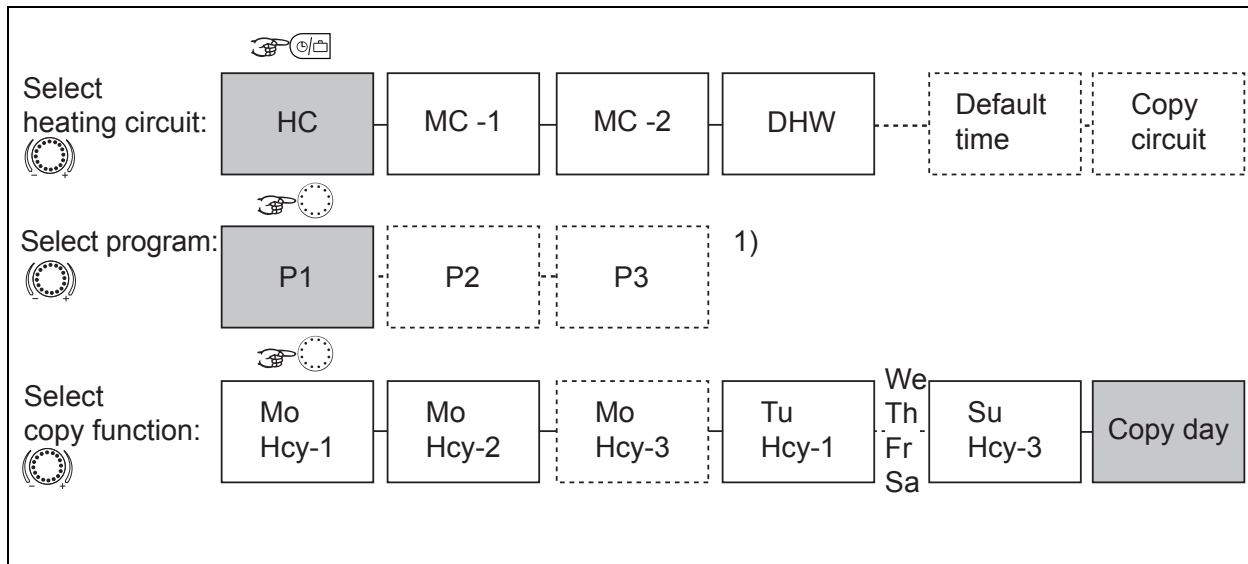

- HC Direct heating circuit
- MC-1 Mixed heating circuit 1
- MC-2 Mixed heating circuit 2
- DHW Hot-water heating circuit

1) Program selection for source and target circuits are skipped if programs P2 and P3 are disabled in the "System Parameter" menu.

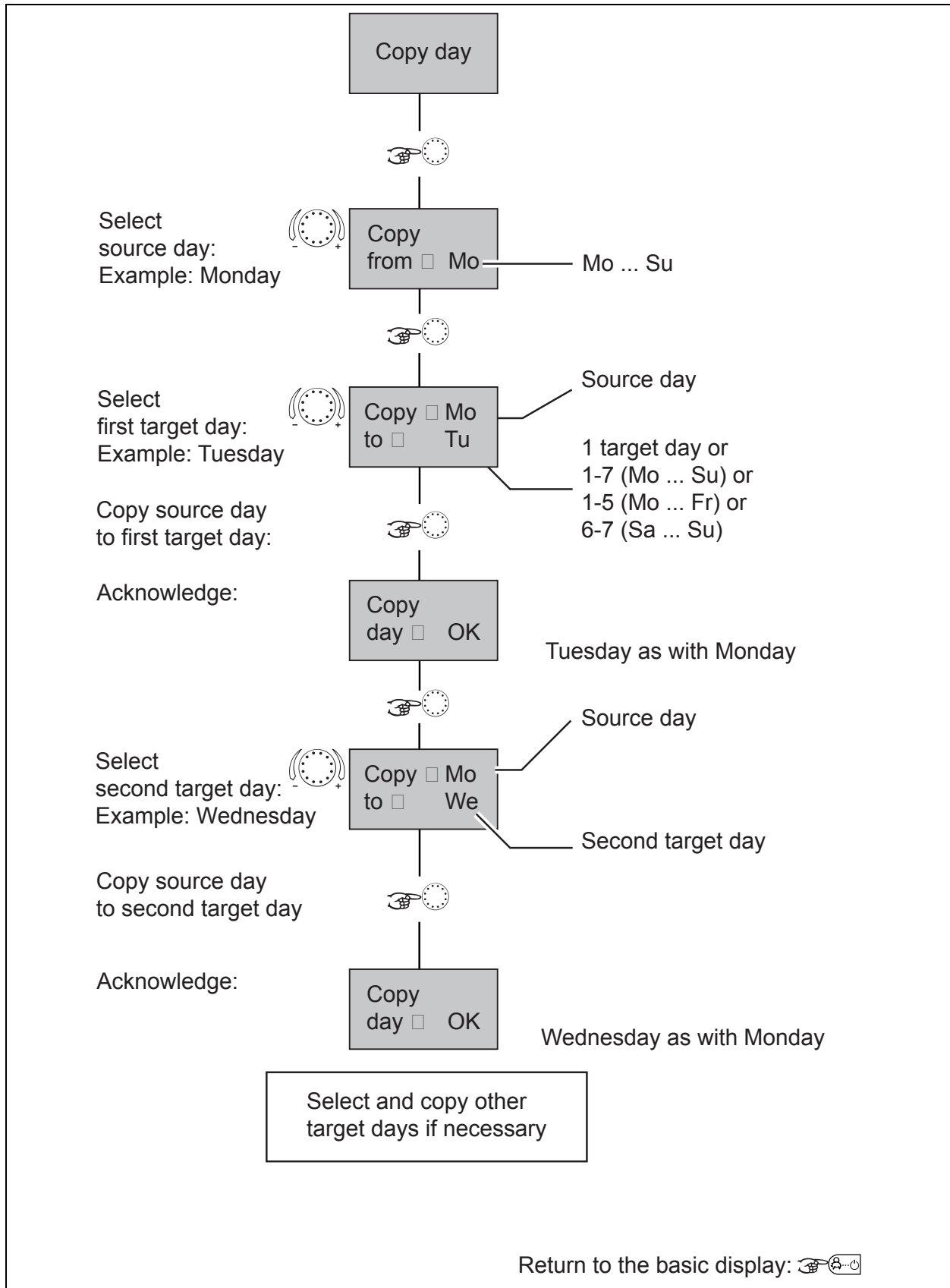

Copying heating circuits

NOTE Heating circuits cannot be copied to hot-water circuits since they have different cycle temperatures: If a heating circuit is selected as the source circuit, the hot-water circuit can no longer be called up as the target circuit. The hot-water circuit as the source circuit is also the target circuit. In this case, only programs of the hot-water circuit are copied among one another if they were enabled in the "System Parameter" menu.

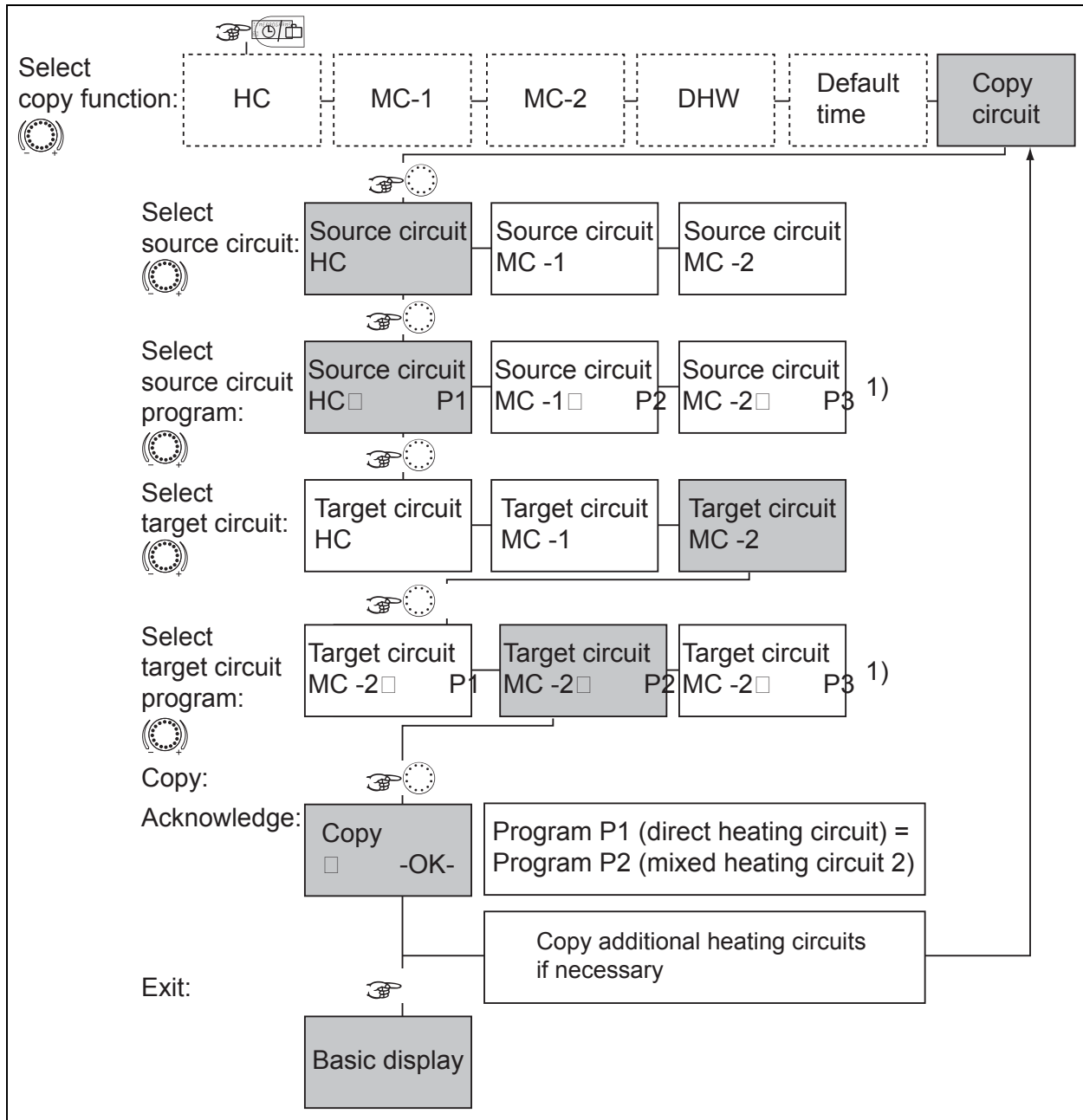

- HC Direct heating circuit
- MC-1 Mixed heating circuit 1
- MC-2 Mixed heating circuit 2
- DHW Hot-water heating circuit
- 1) Program selection for source and target circuits are skipped if programs P2 and P3 are disabled in the "System Parameter" menu.

5.2.2.4.4 Reloading default programs

See flowchart on pg. 70

Individually created switching time program P1, P2 or P3 can be overwritten with the original default switching time program P1, P2 or P3.

For this purpose, select the DEFAULT-TIME function within the heating circuit selection after accessing the "Timeprograms" menu.

After confirming by pressing the input button  , the circuit dedicated to reloading appears flashing (HC, MC-1, MC-2, ALL).

If the automatic programs P1, P2 and P3 (see "System Parameter" menu, program parameter = P1 to P3) were enabled, the desired switching time program P1, P2 or P3 of the heating circuit affected by the reload can be selected. If not enabled, program selection is skipped.

Resetting Resetting then occurs by pressing and holding the input button  approx. 5 s until acknowledgement appears in the display.

Resetting is confirmed by acknowledging COPY OK.

The DEFAULT-TIME function is then called up again to replace other circuits with their default programs if necessary.

▲ ATTENTION

With the setting value ALL, all heating circuits and the hot-water circuit are overwritten with their default switching times with regard to the selected program.

When overwriting occurs, individually created switching time programs are permanently lost and must be recreated from scratch.

Pressing the  button causes an immediate return to the basic display.

Reloading default programs

Switching time programs P2 and P3 disabled

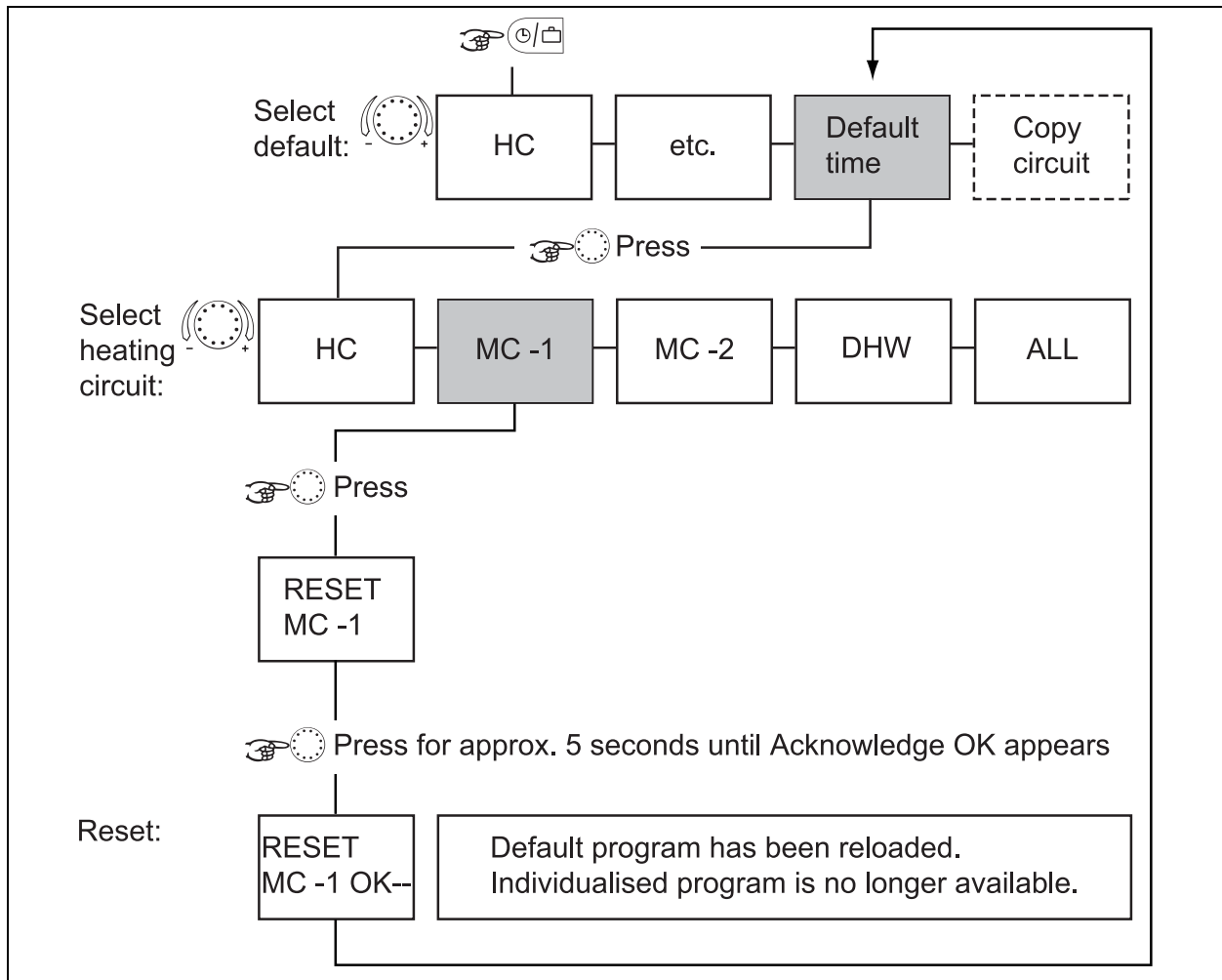

- HC Direct heating circuit
- MC-1 Mixed heating circuit 1
- MC-2 Mixed heating circuit 2
- DHW Hot-water heating circuit

Reloading default programs

Switching time programs P2 and P3 enabled

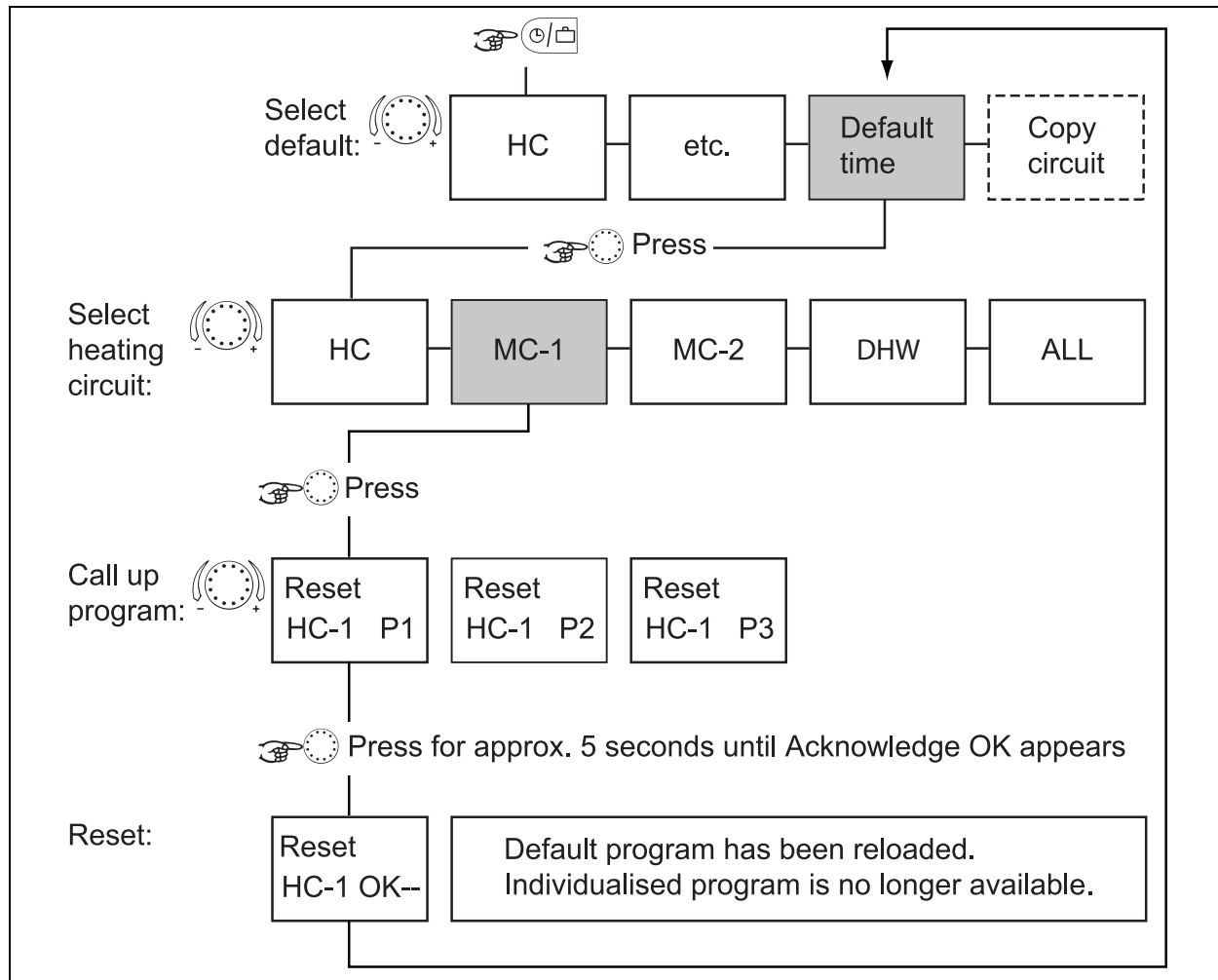

- HC Direct heating circuit
- MC-1 Mixed heating circuit 1
- MC-2 Mixed heating circuit 2
- DHW Hot-water heating circuit

5.2.3 "System Parameters" menu

The system parameters refer to general limiting parameters and specification values within the heating system.

Access See 5.2 Menu-selection level, pg. 48

Returning

Returning to the basic display takes place by pressing the  button or automatically after the set information time (see 5.1.2.7 "**System information**" button, pg. 35).

5.2.3.1 Language selection

Several languages can be selected for all information that appears in the display.

After selecting the language and confirming it by pressing the input button , additional communication takes place in the respective language.

Setting values	DE	German
	GB	English
	FR	French
	IT	Italian
	NL	Dutch
	ES	Spanish
	PT	Portuguese
	HU	Hungarian
	CZ	Czech
	PL	Polish
	RO	Romanian
	RU	Russian
	TR	Turkish
	S	Swedish
	N	Norwegian
DK	Danish	

Factory setting German

5.2.3.2 Time program

This parameter specifies enabling of the switching time programs for program selection and for individualised switching time programming. In the state of delivery, only one switching time program is enabled. This achieves simplification of operation with

a large portion of applications for which only one switching time program is used.

Set values P1 Program 1 = enabled, programs 2 and 3 = disabled
P1 to P3 All three programs enabled

Factory setting P1

Effects In contrast to the previous description, the following setting options are available when programs P1 to P3 are enabled:

- Operating mode selection: In the AUTOMATIC and SUMMER operating modes, switching time program P1, P2 or P3 can be selected.
- Switching time programming: With switching time programming, the three switching time programs, P1 to P3, can be selected for each heating circuit.

5.2.3.2.1 Control mode selection

In the AUTOMATIC and SUMMER control modes, switching time program P1, P2 or P3 can be selected.

5.2.3.2.2 Switching time programming

With switching time programming, the three switching time programs, P1 ... P3 can be selected.

5.2.3.3 Operating mode

Two operating modes can be selected. They determine whether the operating mode, the daytime temperature and the night-time temperature apply for all heating circuits or can be specified individually for each heating circuit.

Setting range 1, 2

Set values

- 1 The selected setting applies for all heating circuits together.
- 2 Each heating circuit can be assigned an individualised setting.

Factory setting 1

5.2.3.3.1 Individualised daytime room temperature for each heating circuit

Setting ► Press button.



► Select desired heating circuit (HC, MC-1 or MC-2) by turning the input button .

► Confirm selected circuit by pressing the input button .

► Set flashing room temperature specification to the desired value by turning the input button .

► Confirm set value by pressing the button.

Alternative: Automatic acceptance of the value after the set information time (see 5.1.2.7 "System information" button, pg. 35).

Setting range 5 ... 30 °C

Factory setting 20 °C

5.2.3.3.2 Individualised night-time room temperature for each heating circuit

Setting



- ▶ Press button.
- ▶ Select desired heating circuit (HC, MC-1 or MC-2) by turning the input button .
- ▶ Confirm selected circuit by pressing the input button .
- ▶ Set flashing room temperature specification to the desired value by turning the input button .
- ▶ Confirm set value by pressing the button.

Alternative: Automatic acceptance of the value after the set information time (see 5.1.2.7 "System information" button, pg. 35).

Setting range 5 ... 30 °C

Factory setting 16 °C

5.2.3.3.3 Individualised operating mode for each heating circuit

Each heating circuit can be assigned an individualised operating mode.

Setting



- ▶ Press button.
- ▶ Select desired heating circuit (HC, MC-1 or MC-2) by turning the input button .
- ▶ Confirm selected circuit by pressing the input button .
- ▶ Select flashing operating mode by turning the input button .
- ▶ Confirm set operating mode by pressing the button or the input button .
- ▶ With short-term operating modes (ABSENT, PARTY), set desired target value by turning the input button and confirm set value by pressing the input button .

Alternative: Automatic acceptance of the value after the set information time (see 5.1.2.7 "System information" button, pg. 35).

This parameter specifies the end of heating operation depending on the outside temperature based on the following criteria:

Quick increase in outside temperature

If the averaged outside temperature is below the set value and the current outside temperature is 2 K above the set value, heating operation is interrupted.

Slow increase in outside temperature

Deactivation is also initiated when the averaged and current outside temperature exceeds the set value.

Undoing deactivation

Deactivation is undone when the averaged **and** current outside temperature exceeds the set value by 1 K.

The summer deactivation function is undone:

- In case of an outside sensor defect
- In case frost protection is active

NOTE During deactivation phases (standby mode, manual summer operation, summer deactivation) lasting longer than 24 hours all pumps are switched on for approx. 20 s and the mixers are temporarily opened during this time to protect against blocking by corrosion.

In connection with a second outside sensor, the current averaged outside temperature is accepted for summer deactivation if the average value of both sensors is specified during outside sensor assignment.

Active summer deactivation is represented by a beach umbrella symbol in the basic display.

Only active in the AUTOMATIC operating mode.

Factory setting 20 °C



Setting range OFF, set value of system frost protection to 40 °C

5.2.3.4 Parameter reset

With the reset parameter, it is possible to reset any inadvertently made changes in the parameter menu to the factory setting.

▲ ATTENTION

A reset should only be carried out if all individually entered values are to be replaced by the values specified at the factory.



- Setting**
- ▶ When the PARAM. RESET  display flashes, press the input button  .
SET flashes in the display.
 - ▶ Press and hold the input button  for 5 s.

If a reset is carried out, the RESET OK confirmation appears briefly. Verification is then started with a call-up of the first parameter in the respective menu once again.

After the parameter values are reset, a return to the first parameter in the "System Parameter" menu occurs.

5.2.3.5 Complete reset

To reset all settings, a complete reset of the device can be carried out.

A complete reset is initiated when the , , and  keys are pressed simultaneously until the controller restarts.

5.2.4 "DHW" menu

This menu contains all parameters required to program the hot-water circuit, except the hot-water switching time programs.

5.2.4.1 Night-time hot-water temperature

This parameter specifies the temperature in the hot-water generator between the operational-readiness times in automatic mode.

Factory setting 40 °C

Setting range 5 °C to set normal hot-water temperature value

NOTE If a hot-water thermostat (see parameter 05 = transducer for hot-water circuit) is used to detect the hot-water temperature, this parameter is skipped.

5.2.4.2 Legionella protection day

Factory setting OFF

Setting range OFF, MO to SU, ALL

Set values	OFF	The legionella protection function is not active.
	MO to SU	Legionella protection is activated on the selected day of the week at the legionella protection time set in the following parameter.
	ALL	The legionella protection function is activated daily at the legionella protection time set in the next parameter.

NOTE If a hot-water thermostat (see 05 parameter = transducer for hot-water circuit) is used to detect the hot-water temperature, these parameters are skipped.

If the legionella protection is active, one of the variable outputs can be enabled. This allows the temporary inactivation of e.g. external limiting facilities in order to execute disinfection.

5.2.5 "Direct Heating Circuit" / "Mixed Heating Circuit 1" / "Mixed Heating Circuit 2" menu

These menus contain all parameters required to program the heating circuit, except the switch time programs. Max. one direct heating circuit and two mixed heating circuits (mixed heating circuit 1 and mixed heating circuit 2) are available as heating circuits.

The following described heating circuit parameters are available separately for setting for each heating circuit.

5.2.5.1 Reduced operation

During reduced operation, you can select between two operating modes.

Factory setting ECO

Setting range ECO, RED

Set values RED (lowering operation)

The heating circuit pump of the direct heating circuit continues functioning during reduced operation (see 5.2.3.2 Time program, pg. 72). The flow temperature is determined based on the lowered room temperature from the associated reduced heating curve. The set maximum temperature is not undershot.

Application Building with minimal insulation values and high cooling loss.

ECO (switch-off operation)

During reduced operation, the direct heating circuit is switched off completely with outside temperatures above the set frost-protection limit. The maximum heat generator temperature is not functional. The heating circuit pump is switched off after a delay to avoid safety deactivation by reheating the heat generator (pump follow-up).

If the outside temperature is or becomes lower than the specified outside temperature frost-protection limit, the controller switches from deactivated (deactivation mode) to lowered lowering operation and controls the heating circuit temperature based on the set lowering curve taking the set minimum heat generator specification into account.

Application Building with high insulation values (full heating protection).

NOTE The mode set here also applies for the ABSENT and RED. HEATING operating modes.

5.2.5.2 Heating system

This parameter refers to the type of the heating system (floor, radiator or convector heating) and can be matched to the exponent of the respective heat distributor. Using its progressive characteristics, the set value determines the curve characteristics of the heating curve of the direct heating circuit and compensates for the losses in output in the low-temperature range with it.

The following settings are recommend depending on the type of heating system:

- UFH Slightly progressive heating curves for floor or other area heating.
- RAD Progressive standard heating curves for all radiator heating with m-values between 1.25 and 1.35.
- CONV Progressive heating curves for convector and baseboard heating.

Factory setting	RAD (radiator systems)
	UFH (floor heating) with mixed heating circuits

Setting range UFH, RAD, CONV

5.3 Error messages

ATTENTION

Inform the heating technician whenever any fault messages are output.

The control device contains substantial error-notification logic. The error messages appear in continuous alteration with the basic display. Multiple errors that occur at the same time appear one after another in the order in which they occurred. The following types of error message exist:

Sensor error messages	Sensor measured values that do not lie in the measurement range are evaluated as an interruption or short-circuit. They appear depending on the type and allocation with fault code 10 to 20 and index 0 for short-circuit or 1 for interruption.
Heat generator error messages	These error messages evaluate the respective switching status. They appear depending on the type and allocation with fault code 30 to 40 and index 0, 1 or 2.

Logical error messages These error messages evaluate the control result to be expected. They appear depending on the type and allocation with fault code 50 to 60 and index 0, 1 or 2.

Bus error messages These error messages refer to address faults such as double issuance or non-recognition of address settings on the data bus. They appear with fault code 70 and index 0 or 1, depending on the type and assignment.

5.4 Parameter settings

5.4.1 "Hydraulics" menu (HYDRAULIC)

The parameters in this menu refer to the general system hydraulics and the functions and configuration of the programmable inputs and outputs for the respective system components. Representative of many individual settings, the applications are **only** defined by the **1st parameter** of this setting table.

Example: The controller is to cover system No 0202. Provided that the controller features enough relays, parameter 01 must be set to value 0202.

Parameter	Designation	Setting range / Setting values	Factory setting	Setting
01	Hydraulic schematic	0, 0101, 0102, ... n	0	
02	Hot-water charging pump output	OFF No function 1 Hot-water charging pump 4 Circulating pump 5 Electric heating rod	1	

Parameter	Designation	Setting range / Setting values	Factory setting	Setting
03	Mixed heating circuit 1 output	OFF No function 2 Direct heating circuit controlled by weather conditions 3 Mixed heating circuit controlled by weather conditions 6 Constant regulator 7 Fixed-value regulator 8 Return maintenance 30 Mixed heating circuit as continuous hot-water pre-regulator (district heating) 39 Hot-water pre-regulator (district heating)	3	
04	Mixed heating circuit 2 output	For setting values, see parameter 03	3	
05	Direct heating circuit pump output	OFF No function 2 Direct heating circuit pump 4 Circulating pump 5 Electric heating element 6 Constant regulation 10 Feeder pump 11 Boiler circuit pump 1 12 Boiler circuit pump 2 13 Group alarm 14 Time switch 15 Solar charging pump 25 Cooling switchover 27 Hydraulic buffer relief 47 Electrical water heater	2	

Parameter	Designation	Setting range / Setting values	Factory setting	Setting
	Direct heating circuit pump output	50 Output for legionella protection		
06	Variable output 1	OFF No function 4 Circulating pump 5 Electrical heating circuit 9 Bypass pump 10 Feeder pump 11 Boiler circuit pump 1 12 Boiler circuit pump 2 13 Group error message 15 Solar charging pump 16 Buffer charging pump 17 Solid fuel charging pump 18 Stratified tank charging pump (DHC) 19 Solar charging switchover 25 Cooling switchover 26 Primary pump 27 Hydraulic buffer relief 47 Electrical water heater 50 Output for legionella protection	OFF	
07	Variable output 2	For setting values, see parameter 06	OFF	
08	Variable input 1	OFF No function 1 Outside sensor 2 2 Heat generator sensor 2 3 Tank sensor 2 4 Buffer sensor 2 5 Request contact 6 External error message input	OFF	

Parameter	Designation	Setting range / Setting values	Factory setting	Setting
08	Variable input 1	7 Return maximum limit of mixed heating circuit 1 8 Return maximum limit of mixed heating circuit 2 9 Return temperature sensor 10 External heat generator cutoff 11 External switching modem 12 External information 13 Total flow sensor 14 Collector return sensor 15 District hot-water stratified tank charge sensor 16 Exhaust gas sensor 18 Solids buffer sensor 19 Buffer sensor 1 29 Hygrostatic switch-off 30 Room sensor NTC 20 of direct heating circuit 31 Room sensor NTC 20 of mixed heating circuit 1 32 Room sensor NTC 20 of mixed heating circuit 2 50 Remote control TF22 for DK1 51 Remote control TF22 for MK1 52 Remote control TF22 for MK2		
09	Variable input 2	For setting values, see parameter 08; does not include setting value 16 (exhaust gas sensor), however	OFF	

Parameter	Designation	Setting range / Setting values	Factory setting	Setting
10	Variable input 3	For setting values, see parameter 08; does not include setting value 16 (exhaust gas sensor), limit sensor of district heating VFB, however	OFF	
11	Indirect return lifting via mixed heating circuit	OFF, ON	OFF	

5.4.2 "System parameters" menu (SYSTEM)

The parameters in this menu refer to general limit parameters and specification values in the heating system used.

Parameter	Designation	Setting range / Setting values	Factory setting	Setting	
Language selection**	Language selection	DE	German	DE	
		GB	English		
		GR	Greek		
		FR	French		
		IT	Italian		
		NL	Dutch		
		ES	Spanish		
		PT	Portuguese		
		HU	Hungarian		
		CZ	Czech		
		PL	Polish		
		RO	Romanian		
		RU	Russian		
		TR	Turkish		
		SE	Swedish		
		NO	Norwegian		
GR	Greek				

Parameter	Designation	Setting range / Setting values	Factory setting	Setting
Time program	Time program	P1 Only one switching time program enabled P1 to P3 Three switching time programs enabled	P1	
Operating mode	Operating mode	1 Common adjustment for all heating circuits 2 Separate adjustment for the individual heating circuits	1	
Summer	Summer switch-off	OFF, setting value of parameter 05 to 30°C	20	
05	System frost protection	OFF, -20°C to Setting value of summer parameter	3	
06	Request contact module for variable input 1	1 Direct heating circuit 2 Mixed heating circuit 1 3 Mixed heating circuit 2 4 Hot-water circuit ALL All controllers	1	
07	Request contact module for variable input 2	For setting values, see parameter 06	1	
08	Request contact module for variable input 3	For setting values, see parameter 06	1	
09	Climate zone	-50 ... 0°C	-12	
10	Building type	1 Light construction 2 Medium construction 3 Heavy construction	2	

Parameter	Designation	Setting range / Setting values		Factory setting	Setting
11	Automatic exit time	OFF	No automatic exit	2	
		0,5 ... 5 min	Automatic jump back to the basic display occurs after the set time		
12	Anti-blocking protection	ON	Anti-blocking protection active	ON	
		OFF	Anti-blocking protection not active		
13	Logical fault messages	OFF, ON		OFF	
14	Automatic set function	OFF, ON		OFF	
15*	Locking code for heating technician	OFF, 0001 to 9999		1234	
16*	Type code	Controller type corresponding to type code table		Type	
18	Cycle temperature enable	OFF	Cycle temperature disabled	ON	
		ON	Cycle temperatures enabled		
19	Frost-protection mode	OFF	Continuous frost protection as per parameter 05	OFF	
		0.5 to 60 min	Cyclic operation		

Parameter	Designation	Setting range / Setting values	Factory setting	Setting
21*	Adjustment of the real time clock (RTC)	-10 ... 10 s	0	
23	Locking code for operating level	OFF, 0000 ... 9999	OFF	
25	Cooling switch-on temperature	2 ... 10 K	6	
28	Error memory 2	OFF, ON	OFF	
29*	Characteristic curve for emergency operation without outside sensor	-50 to 30°C	0	
Selection of SDC/ DHC	Selection of SDC/DHC	SDC, DHC	SDC	
Parameter reset	Parameter reset	SET by pressing the input button	-	

* OEM

** Other controllers also allow other language variants.

5.4.3 "Hot-water circuit" menu (DHW)

This menu contains all parameters required to program the hot-water circuit, except the switch time programs.

Parameter	Designation	Setting range / Setting values	Factory setting	Setting
Hot water	Hot water at night	10°C to normal hot-water temperature	40	
Legio protection day	Legionella protection day	OFF No legionella protection Mon to Sun Legionella protection on specified day of week ALL Legionella protection every day	OFF	
03	Legionella protection time	00:00 ... 23:00 hours	02:00	
04	Legionella protection temperature	10 °C to setting value of parameter 06	65	
05	Transducer for hot-water circuit	1 Hot-water circuit temperature sensor 2 Hot-water circuit temperature controller (thermostat)	1	
06	Maximum temperature limit for hot water circuit	20°C to heat generator maximum temperature If parameter 07 = 7: 20 to 90°C. In automatic mode, from hot-water circuit minimum temperature.	65	

Parameter	Designation	Setting range / Setting values	Factory setting	Setting
07	Hot-water circuit operating mode	1 Parallel operation 2 Priority operation 3 Conditional priority 4 Parallel operation based on weather conditions 5 Priority operation with intermediate heating 6 Priority isolating circuit 7 External operation 8 Conditional parallel operation for mixed heating circuit (DHC only)	2	
08	Tank discharge protection	OFF No discharge protection Switching differential 5 ... 30 K	5	
09	Temperature increase of heat generator with hot-water circuit charging	0 ... 50 K Difference between hot-water circuit charging temperature and hot-water circuit setpoint temperature	15	
10	Switching differential of hot-water circuit	2 ... 20 K Value of hot-water circuit switching differential. Symmetrical effect around the hot-water circuit setpoint	5	
11	Hot-water charging pump follow-up time	0 ... 60 min	5	

Parameter	Designation	Setting range / Setting values	Factory setting	Setting
12	Circulation pump switching time program	AUTO Active hot-water circuit time program 1 P1, direct heating circuit 2 P2, direct heating circuit 3 P3, direct heating circuit 4 P1, mixed heating circuit 1 5 P2, mixed heating circuit 1 6 P3, mixed heating circuit 1 7 P1, mixed heating circuit 2 8 P2, mixed heating circuit 2 9 P3, mixed heating circuit 2 10 P1, hot-water circuit 11 P2, hot-water circuit 12 P3, hot-water circuit	AUTO	
13	Economy interval pause of circulating pump	0 ... setting value of parameter 14 Switch-on interval while the circulating pump is running	5	
14	Economy interval cycle (period duration)	1 ... 60 min	20	
15	Switching differential for storage charge	POS, NEG, SYM	SYM	
16	Circulating pump	1 Normal operation 2 Switched off during hot-water circuit charging	1	

Parameter	Designation	Setting range / Setting values	Factory setting	Setting
17	Behaviour of heat generator during follow-up time	AUTO Setpoint at heat generator depending on demand OFF Heat generator off during follow-up time of solar charging pump	AUTO	
28	Switch-on delay time for electrical water heater	0 ... 600 min	60 min	
29	Offset setpoint for Electrical water heater	-1 ... 99 K	-5 K	

5.4.4 "Direct heating circuit" menu (UNMIXED CIRC)

This menu contains all parameters required to program the un-mixed heating circuits, except the switching time programs.

Parameter	Designation	Setting range / Setting values	Factory setting	Setting
Heat-ing curve	Slope	OFF, 0.02 to 3.50	1.5	
Re-duced	Reduced operation	ECO Switch-off operation RED Lowering operation	ECO	
Heat-ing system	Heating system	UFH Under floor heating	RAD	
		RAD Radiator		
		CON V Convectector heater		

Parameter	Designation	Setting range / Setting values	Factory setting	Setting
03	Room connection (in conjunction with room sensor)	OFF Display of heat generator temperature, room sensor off, operation active 1 Display of room temperature, room sensor active, operation active 2 Display of room temperature, room sensor active, operation disabled 3 Display of room temperature, room sensor off, operation active	OFF	
04	Room factor	OFF 10 ... 500 % Influence active RC Room controller active	OFF	
07	Heating limit	OFF, 0.5 to 40 K	OFF	
08	Room frost-protection limit	5 ... 30°C	10	
09	Room thermostat function	OFF, 0.5 to 5 K	OFF	
10	Assignment of outside sensor	0 Regulation to average value (outside sensor 1 + outside sensor 2) 1 Regulation to outside sensor 1 2 Regulation to outside sensor 2	0	
11	Constant temperature setpoint (day)	10 ... 95°C	20	

Parameter	Designation	Setting range / Setting values	Factory setting	Setting
12	Minimum temperature limit	10°C to setting value of parameter 13	20	
13	Maximum temperature limit	Setting value of parameter 12 to Setting value of parameter 30 in "Heat generator" menu (OEM maximum limit)	75	
14	Temperature increase of heating circuit	-5 ... 20 K	Direct heating circuit = 0	
15	Extended pump over-run	0 ... 60 min	5	
23	Room control C-factor (SDW 30 only)	1 ... 100	8	
24	Room control T _n (SDW 30 only)	5 ... 240 min	35	
25	Holiday operating mode	STBY Standby RED Lowering operation	STBY	
26	Room setpoint ramp	OFF, 0.5 to 60 K/h	OFF	
41	Switch-on optimisation	OFF 1 Adaption off 2 Adaption on 3 Adaption restart	OFF	
42	Min. pre-heat time	0 ... setting value of parameter 43	0,5	
43	Max. pre-heat time	Setting value of parameter 42 to 30 h	5	
44	Min. jump back temperature	0 ... 30°C	5	
45	Without room sensor	0 ... 10°C	1	
46	Pre-heat time at 0°C	0 ... 30 h	1	
47	Lowering ramp	0 ... 500 %	100	

Parameter	Designation	Setting range / Setting values	Factory setting	Setting
Heating circuit name	Heating circuit name	00000 ... ZZZZZ	–	
48	Constant temperature setpoint (night)	10 ... 95°C (only for reduced operation = RED)	20	

5.4.5 "Mixed heating circuit 1 / 2" (MIX.VALVE - 1 / MIX.VALVE - 2) menus

These menus contain all parameters required to program the mixed heating circuit, except the switching time programs.

Parameter	Designation	Setting range / Setting values	Factory setting	Setting
Heating curve	Slope	OFF, 0.02 to 3.50	1	
Reduced	Reduced operation	ECO Switch-off operation RED Lowering operation	ECO	
Heating system	Heating system	UFH Floor heating RAD Radiator CONV Convector heater	RAD	

Parameter	Designation	Setting range / Setting values	Factory setting	Setting
03	Room connection (in conjunction with room sensor)	OFF Display of heat generator temperature, room sensor off, operation active 1 Display of room temperature, room sensor active, operation active 2 Display of room temperature, room sensor active, operation disabled 3 Display of room temperature, room sensor off, operation active	OFF	
04	Room factor	OFF Influence active 10 ... 500 % RC Room controller active	OFF	
07	Heating limit	OFF, 0.5 to 40 K	OFF	
08	Room frost-protection limit	5 ... 30 °C	10	
09	Room thermostat function	OFF, 0.5 to 5 K	OFF	
10	Assignment of outside sensor	0 Regulation to average value (outside sensor 1 + outside sensor 2) 1 Regulation to outside sensor 1 2 Regulation to outside sensor 2	0	

Parameter	Designation	Setting range / Setting values	Factory setting	Setting
11	Constant temperature setpoint (only if output was set to constant regulator)	10 ... 95°C	20	
12	Minimum temperature limit	10°C to setting value of parameter 13	20	
13	Maximum temperature limit	Setting value of parameter 12 to Setting value of parameter 30 in "Heat generator" menu (OEM maximum limit)	75	
14	Temperature increase of heating circuit	-5 ... 20 K	Mixed heating circuit = 4	
15	Follow-up time of pump	0 ... 60 min	5	
16	Screed function	OFF 1 Functional heating 2 Screed-drying heating	OFF	
17	Return maximum temperature limit	10 ... 90 °C	90	
18	P part X_P	1 ... 50 %/K	2	
19*	Sampling time T_s	1 ... 600 s	20	
20	I part T_n	1 ... 600 s	270	
21	Actuator runtime	10 ... 600 s	120	
22*	Actuator end position function	1 Continuous control signal in end position 2 Control signal suppressed at end position (actuator de-energised)	1	
23	Room control C-factor (SDW 30 only)	1 ... 100	8	

Parameter	Designation	Setting range / Setting values	Factory setting	Setting
24	Room control T _n (SDW 30 only)	5 ... 240 min	35	
25	Holiday operating mode	STBY Standby RED Lowering operation	STBY	
26	Room setpoint ramp	OFF, 0.5 ... 60 K/h	OFF	
28	Cooling temperature of mixed heating circuit	OFF, 5 to 24	OFF	
39	Spread of hot-water circuit pre-regulator	2 ... 20 K	5	
40	Offset valve position of hot-water circuit pre-regulator	0 ... 100 %	0	
41	Switch-on optimisation	OFF 1 Adaptation off 2 Adaptation on 3 Adaptation restart	OFF	
42	Minimum pre-heat time	0 ... setting value of parameter 43	0.5	
43	Maximum pre-heat time	Setting value of parameter 42 to 30 h	5	
44	Min. jump back temperature	0 ... 30 °C	5	
45	Without room sensor	0 ... 10 °C	1	
46	Pre-heat time at 0 °C	0 ... 30 h	1	
47	Lowering ramp	0 ... 500 %	100	

Parameter	Designation	Setting range / Setting values	Factory setting	Setting
Heating circuit name	Heating circuit name	00000 ... ZZZZZ	–	
48	Constant temperature setpoint (night)	10 ... 95°C (only for reduced operation = RED)	20	

* OEM

5.4.6 "Heat generator" menu (HEAT GENER.

The parameters in this menu refer to the type of the respective heat generator and the associated specific control functions.

Parameter	Designation	Setting range / Setting values	Factory setting	Setting
01	Design	OFF Without heat generator 1 Oil/gas - one stage 2 Oil/gas - two stages 3 Oil/gas - 2 x one stage 4 Modulating burner 5 Open Therm	1	
02	Start-up protection (not if parameter 01 = OFF)	OFF No start-up protection 1 Unlimited start-up protection 2 Start-up protection controlled by weather conditions 3 Start-up protection disconnected	1	
03	Minimum temperature limit (not if parameter 01 = OFF)	5°C to setting value of parameter 04	38 (5 with automatic operation)	

Parameter	Designation	Setting range / Setting values	Factory setting	Setting
04	Maximal temperature limit (not if parameter 01 = OFF)	Setting value of parameter 03 to setting value of parameter 30 (OEM maximum limit)	80	
06	Sensor operating mode	1 Burner switch-off in case of defect 2 External burner switch-off 3 Burner enable in case of defect	1	
07	Minimum burner runtime	0 ... 20 min	2	
08	Burner switching differential I	One stage: 2 ... 30 K Two stages: 2 ... (setting value of parameter 09 – 0.5 K)	6	
09	Burner switching differential II (not if parameter 01 = 2)	(setting value of parameter 08 + 0.5) to 30 K	8	
10	Connection delay stage II	0 ... 60 min (0 = 10 s)	0	
11	Boiler start-up relief stage II	1 Unlimited enable during start-up relief 2 Time-out during start-up relief	2	

Parameter	Designation	Setting range / Setting values	Factory setting	Setting
13	Lead time of boiler circuit pump or parallel heat generator enable (only with appropriate configuration in the "Hydraulics" menu)	0 ... 10 min	0	
14	Follow-up time of boiler circuit pump (only with appropriate configuration in the "Hydraulics" menu)	0 ... 60 min	2	
15	Follow-up time of feeder pump (only with appropriate configuration in the "Hydraulics" menu)	0 ... 60 min	2	
16	Exhaust gas temperature monitoring (only with appropriate configuration in the "Hydraulics" menu)	OFF Display of exhaust gas temperature only 0 ... 60 min Heat generator lock if limit value is exceeded for set time SLT Heat generator lock if limit value is exceeded	OFF	
17	Exhaust gas limit value (only with appropriate configuration in the "Hydraulics" menu)	50 ... 500°C	200	

Parameter	Designation	Setting range / Setting values	Factory setting	Setting
19	Modulation of proportional range X_P	0.1 ... 50 %/K	5	
21	Modulation of adjustment time T_n	1 ... 600 s	180	
22	Modulation of runtime	5 ... 600 s	12	
23	Modulation of start time	0 ... 900 s	60	
24	Modulation of start power	0 ... 100 %	70	
25	Outside temperature lock (not if parameter 01 = OFF)	OFF, -20 to +30 °C	OFF	
26	Base load increase	0 ... 60 K	30	
27	Minimum temperature limit of heating circuits (only if parameter 02 = 3)	5 °C to setting value of parameter 03	36	
28	Switching differential of minimum temperature limit of heating circuits (only if parameter 02 = 3)	2 ... 20 K	4	
29	Heat generator forced discharge	OFF 1 Discharge to process water tank 2 Discharge to heating circuits 3 Discharge to buffer tank	OFF	

Parameter	Designation	Setting range / Setting values	Factory setting	Setting
30*	OEM maximum limit	Setting value of parameter 03 to 130 °C	110	
31*	Full-load regulation	OFF, 0.5 to 10	OFF	
34	Power limit for heating	50 ... 100 %	100	
35	Power limit for hot water	50 ... 100 %	100	
37	Burner counter mode (counter of operating hours)	AUTO 1 Feedback only 2 Free counter	AUTO	
38	Outside temperature lock, inverse	OFF, -20 to +30 °C	OFF	
39	Fixed delay (Cascade)	Off, 1...300min	OFF	
RESET ST-1	Resetting of burner start counter and operating hours of stage 1 (not if parameter 01 = OFF)	SET by pressing the input button	–	
RESET ST-2	Resetting of burner start counter and operating hours of stage 2 (not if parameter 01 = 2 or 01 = OFF)	SET by pressing the input button	–	

* OEM

5.4.7 "District hot water" menu (DIST.HEATING)

The parameters in this menu refer to the type of the respective district hot-water station and the associated specific control functions.

Parameter	Designation	Setting range / Setting values	Factory setting	Setting
01	Increase	OFF, -10 to 50 K	0	
02	Maximum limit of flow temperature setpoint	10 ... 130 °C	90	
03*	Minimum district heating valve stroke	0 ... 50 %	10	
04	Secondary flow boost	0,1 ... 30 %/K	5	
05	Adjustment time	0 ... 60 min	3	
06	Runtime of district heating valve 1	10 ... 1800 s	120	
07*	Runtime of district heating valve 2	10 ... 1800 s	30	
08	Maximum return temperature setpoint	0 ... 100 °C	90	
09	Application point variable district heating return temperature	OFF, -40 to +10 °C	OFF	
10	Maximum return temperature setpoint with hot water circuit charge	0 ... 100 °C	90	

Parameter	Designation	Setting range / Setting values	Factory setting	Setting
11	Return limit of district heating valve	0 Temperature (parameters 12 through 15 are not displayed) 1 Volume flow and temperature (parameters 12 through 14 are not displayed) 2 Heat output and temperature (parameters 13 through 15 are not displayed)	0	
12*	Calibration of heat output	1 ... 9999	1	
13*	Calibration of volume flow	1 ... 9999	1	
14*	Maximum heat output	1 ... 9999 kW	9999	
15*	Maximum volume flow	0,01 ... 99.99 m ³ /h	99.99	
16	Increase in return temperature at legionella function	OFF, 0,5 ... 20K	OFF	

* OEM

5.4.8 "Return increase" menu (RETURN CONTR)

The parameters in this menu refer to special settings with regard to the increase in return temperature with heat generators.

Enabling occurs only with corresponding activation in the "Hydraulics" menu.

Parameter	Designation	Setting range / Setting values	Factory setting	Setting
01	Return temperature setpoint	10 ... 95°C	20	

Parameter	Designation	Setting range / Setting values	Factory setting	Setting
02	Switch-off differential	1 ... 20 K	2	
03	Follow-up time of pump	0 ... 60 min	1	

5.4.9 "Solar" menu (SOLAR)

The parameters in this menu refer to special settings with regard to the solar applications.

Enabling occurs only with corresponding activation in the "Hydraulics" menu.

Parameter	Designation	Setting range / Setting values	Factory setting	Setting
01	Switch-on differential	(Setting value of parameter 02 + 3 K) to 30 K	10	
02	Switch-off differential	2 K to (setting value of parameter 01 – 3 K)	5	
03	Minimum runtime of solar charging pump	0 ... 60 min	3	
05*	Buffer maximum temperature limit	20 ... 110°C	75	
06	Operating mode	1 Priority operation 2 Parallel operation 3 Priority operation of hot-water circuit 4 Priority operation of buffer	2	
07	Heat generator cycle inhibitor (only if parameter 06 = 1)	OFF, 0.5 to 24 h	OFF	
08	Solar priority parallel switchover	OFF, 1 to 30 K	OFF	

Parameter	Designation	Setting range / Setting values	Factory setting	Setting
09	Heat balance	OFF No heat balancing 1 Heat balancing via flow-through calculation 2 Heat balancing via pulse input	OFF	
10	Reset heat balance	SET by pressing the input button	–	
11	Volume flow	0 ... 30 L/min or L/pulse	0	
12	Density of medium	0.8 ... 1.2 kg/L	1.05	
13	Heat capacity of medium	2 ... 5 KJ/kgK	3.6	
15	Test cycle of solar charging switchover	1 ... 60 min	10	
16	Switchover temperature	20 ... 110 °C	75	

* only accessible via Honeywell-Code

5.4.10 "Solid" menu (SOLID FUEL)

The parameters in this menu refer to special settings with regard to solids regulation.

Enabling occurs only with corresponding activation in the "Hydraulics" menu.

Parameter	Designation	Setting range / Setting values	Factory setting	Setting
01	Minimum temperature	20 ... 80 °C	60	
02	Maximum temperature	30 ... 100 °C	90	
03	Switch-on differential	(Setting value of parameter 04 + 3 K) to 20 K	10	
04	Switch-off differential	2 K to (setting value of parameter 03 – 3 K)	5	

Parameter	Designation	Setting range / Setting values	Factory setting	Setting
05	Heat generator cycle inhibitor	OFF, 2 to 180 min	OFF	

5.4.11 "Buffer" menu (BUFFER)

The parameters in this menu refer to special settings with regard to solids regulation.

Enabling occurs only with corresponding activation in the "Hydraulics" menu.

Parameter	Designation	Setting range / Setting values	Factory setting	Setting
01	Minimum temperature	5 °C to setting value of parameter 02	20	
02	Maximum temperature	Setting value of parameter 01 to 95 °C	80	
03	Boiler temperature increase	-10 to 80 K	0	
04	Buffer switching differential	1 to 70 K	2	
05	Forced discharge	OFF 1 In process water tank 2 In heating circuits	OFF	
06	Follow-up switch-on differential	OFF, (setting value of parameter 07 + 2 K) to 50 K	10	
07	Follow-up switch-off differential	1 K to (setting value of parameter 06 – 2 K)	5	
08	Buffer start-up protection	OFF No start-up protection Switching differential 5 ... 20 K	ON 5	
09	Buffer discharge protection	OFF No discharge protection ON Discharge protection active	ON	

Parameter	Designation	Setting range / Setting values	Factory setting	Setting	
10	Buffer operating mode	1	Heating circuit charge regulation and hot-water circuit	1	
		2	Heating circuit charge regulation without hot-water circuit		
		3	Heating circuit and hot-water circuit discharge regulation		
		4	Heating circuit discharge regulation without hot-water circuit		
		5	Charge regulation with hot-water circuit switchover		
		6	Discharge regulation for heat generator		
11	Follow-up time of buffer charging pump	0 ... 60 min	3		

5.4.12 "Total flow regulation" menu (MAIN SUPPLY)

The parameters in this module refer to special settings with regard to total flow regulation.

This selection is only available if a total flow sensor is configured on one of the variable inputs (see the "Hydraulics" menu, parameters 08, 09 or 10).

Parameter	Designation	Setting range / Setting values	Factory setting	Setting
01	Regulation	0 ... 50 %/K	5	
03	Regulation	1 ... 600 s	180	

5.4.13 "Cascading" menu (CASCADE)

The parameters in this menu refer solely to the parameters that are associated with the cascading of multiple heat generators.

This selection is only available if multiple heat generators exist in the control system.

Parameter	Designation	Setting range / Setting values	Factory setting	Setting
01	Switching differential	0.5... 30 K	4	
02	Connection delay	0 ... 200 min	0	
03	Switch-off delay	0 ... 60 min	0	
04	Switchover power of stage sequence	10 ... 100 %	65	
05	Stage reversal	OFF, 1 to 250 h	OFF	
06	Guidance stage	1 ... maximum number of stages	1	
07	Peak-load stage	OFF, 2 ... maximum number of stages All heat generators are numbered consecutively within the cascade. The total quantity determines the maximum number of stages.	OFF	
08	Switchover of base load with grouping	OFF, ON	OFF	
09*	Quick hot-water connection	OFF, 1 ... maximum number of stages	OFF	

* OEM

5.4.14 "Data bus" menu (BUS)

The parameters in this menu refer solely to the parameters that are associated with the data bus.

Parameter	Designation	Setting range / Setting values	Factory setting	Setting
01	Central device address	10, 20, 30, 40, 50	10	
02	Bus authorisation SDW 30 of direct heating circuit	1 Expanded access authorisation 2 Simple access authorisation	1	
03	Bus authorisation SDW 30 of mixed heating circuit 1	1 Expanded access authorisation 2 Simple access authorisation	1	
04	Bus authorisation SDW 30 of mixed heating circuit 2	1 Expanded access authorisation 2 Simple access authorisation	1	
05	Cascading operation	OFF, ON	ON	

5.4.15 "Relay test" menu (RELAY TEST)

In this menu, the relays contained within the central device can be selected via the input button and checked for operation.

Parameter	Designation	Setting range / Setting values	Factory setting	Setting
01	Heat generator test	Different relay switching sequence depending on the set heat generator	–	
02	Direct heating circuit pump test	OFF-ON-OFF	OFF	
03	Mixed heating circuit pump 1 test	OFF-ON-OFF	OFF	
04	Mixer motor 1 test	STOP-OPEN-CLOS	STOP	

Parameter	Designation	Setting range / Setting values	Factory setting	Setting
05	Mixed heating circuit pump 2 test	OFF-ON-OFF	OFF	
06	Mixer motor 2 test	STOP-OPEN-CLOS	STOP	
07	Storage charging pump test	OFF-ON-OFF	OFF	
08	Variable output 1 test	OFF-ON-OFF	OFF	
09	Variable output 2 test	OFF-ON-OFF	OFF	
10	System	Display of sensor value by pressing the input button	–	

5.4.16 "Error messages" menu (ALARM)

Error messages that occur are displayed in this menu. The fault memory can hold max. 20 messages, which can be displayed individually.

Parameter	Designation	Setting range / Setting values	Factory setting	Setting
01	Error message 1	Last error message	"Display"	
02	Error message 2	Last error message but one	"Display"	
03	Error message 3	Last error message but two	"Display"	
04	Error message 4	Last error message but three	"Display"	
05	Error message 5	Last error message but four	"Display"	
...				
20	Error message 20	First error message	"Display"	
21*	Reset error messages	SET by pressing the input button	–	

* OEM

5.4.17 "Error messages 2" menu (ALARM 2)

Only in conjunction with heat generator interface

Error messages triggered by an automatic stoker are displayed in this menu. The fault memory can hold max. 20 messages, which can be displayed individually.

For this purpose, parameter 28 in the "System parameters" menu must be set to ON.

Parameter	Designation	Setting range / Setting values	Factory setting	Setting
01	Error message 1	Last error message	"Display"	
02	Error message 2	Last error message but one	"Display"	
03	Error message 3	Last error message but two	"Display"	
04	Error message 4	Last error message but three	"Display"	
...				
20	Error message 20	First error message	"Display"	
21*	Reset error messages	SET by pressing the input button	–	

* OEM

5.4.18 "Service" menu (SERVICE)

With this menu the controller's function can be tested at the commissioning process.

For this, the outside temperature will be given via parameter 1. This preset equates the actual and the delayed outside temperature – in order allowing testing e.g. frost protection or switching behavior (heating/cooling).

NOTE After 20 min, the controller automatically switches to the sensor value again.

Parameter	Designation	Setting range / Setting values	Factory setting	Setting
01	Outside temperature specification	OFF, –50 ... +30°C	OFF	

5.4.19 "Sensor calibration" menu (SENSOR ADJ.)

In this menu, all sensors connected to the central device can be corrected by ± 5 K based on the factory calibration value.

Parameter	Designation	Setting range / Setting values	Factory setting	Setting
01	Outside sensor	-5 ... +5 K	0	
02	Heat generator sensor	-5 ... +5 K	0	
03	Hot-water sensor	-5 ... +5 K	0	
04	Flow sensor of mixed heating circuit 1	-5 ... +5 K	0	
05	Flow sensor of mixed heating circuit 2	-5 ... +5 K	0	
06	Collector flow sensor	-5 ... +5 K	0	
07	Buffer sensor of collector	-5 ... +5 K	0	
08	Sensor of variable input 1	-5 ... +5 K	0	
09	Sensor of variable input 2	-5 ... +5 K	0	
10	Sensor of variable input 3	-5 ... +5 K	0	
11	Room sensor SDW 10 of direct heating circuit	-5 ... +5 K	0	
12	Room sensor SDW 10 of mixed heating circuit 1	-5 ... +5 K	0	
13	Room sensor SDW 10 of mixed heating circuit 2	-5 ... +5 K	0	

6 Control Functions

6.1 Variable adjustment of the hydraulic parameters (variable inputs and outputs)

The hydraulic presetting of the inputs and outputs of the controller selected via the "Hydraulics" menu, Parameter 01 can be adjusted individually. The preset hydraulics parameters can be changed individually for this purpose. Thus hydraulics not covered by the automatic preconfiguration can also be implemented.

▲ ATTENTION

The hydraulic parameters define the system. Changes can have far-reaching effects on the way the controller works. Parameter settings made elsewhere can be lost. Individual adjustments must therefore be made very carefully!

Only those inputs and outputs that are actually present on the controller are available for setting in the "Hydraulics" menu.

The function of the corresponding output is determined by the setting of the hydraulic parameter.

Example:

Parameter 05 defines the function assignment of the output for the direct heating circuit pump (DHCP). Ex works, this output is set to the corresponding setting for the direct heating circuit pump.

If this output is assigned the "circulation pump" function, the direct heating circuit pump function is no longer available.

A function can only be executed if the corresponding function is also available in the hydraulic system.

Example:

The parameters for setting the circulation pump are not accessible until the direct heating circuit pump output is assigned to the "circulation pump" function, for example.

If a variable function requires an input value (sensor), then this sensor will be assigned to the matching variable input. This input can then no longer be changed manually.

If individual settings were previously made for the associated input, they are overwritten and the corresponding functions are reset.

Example:

A second outside sensor is assigned to variable input 1. The "buffer loading pump" function is now assigned to variable output 1. The variable input is now reset automatically (outside sensor 2 no longer active). The buffer sensor is then assigned to it, as it is required for correction.

6.1.1 Connection and settings table

Function	Adjustable at output	Inputs		Comment
		Fixed assignment	Optional (VI 1/2)	
DHW loading	SLP	SF	---	Fixed sensor input
Direct heating circuit controlled by weather conditions	DKP, MK-1, MK-2	---	---	
Mixed heating circuit controlled by weather conditions	MK-1, MK-2	VF1, VF2	---	Fixed sensor input for respective mixed heating circuit
Circulation pump	SLP, DKP, VA1, VA2	---	---	
Electric heating rod	SLP, DKP, VA1, VA2	---	---	
Constant control	DKP, MK-1, MK-2	VF1, VF2	---	Sensor for connection to MK
Fixed-value control	MK-1, MK-2	VF1, VF2	---	Sensor for connection to MK
Boiler return control	MK-1, MK-2	VF1, VF2	---	
Bypass pump (..VV..)	VA1, VA2	---	---	
Charging pump	DKP, VA1, VA2	---	---	
Boiler circuit pump 1	DKP, VA1, VA2	---	---	

Function	Adjustable at output	Inputs		Comment
		Fixed assignment	Optional (VI 1/2)	
Boiler circuit pump 2	DKP, VA1, VA2	---	---	
Global malfunction message	DKP, VA1, VA2	---	---	
Timer	DKP	---	---	
Solar loading pump (SDC 8-21, SDC 9-21, SDC 12-31, DHC 43-2)	DKP, VA1, VA2	KVLF, KSPF	KRLF (14)	Return flow sensor option
Buffer loading pump (SDC 8-21, SDC 9-21, SDC 12-31, DHC 43-2)	VA1, VA2	PF	PF1 (19)	Fixed assignment to VI if PLP is set to PF. Otherwise, PF1 can be adjusted at free VI (activation of buffer management)
Solid-fuel loading pump	VA1, VA2	FKF	FPF (18)	SFS in fixed assignment to corresponding VI; standard buffer sensor is KSPF; separate solid-fuel buffer tank sensor SFB can be configured (optional)
Stratified tank loading pump (DHC 43-2)	VA1, VA2	SSLP	---	
Solar loading valve	VA1, VA2	SLVF	----	SLVS in DHW storage; KSPF in buffer
Solar forced dissipation valve	VA1, VA2			

6.2 Switching time program enabling

The modular Smile SDC/DHC 43 series of controllers features three switching time programs for each heating circuit that can be set separately.

When supplied, only one switching time program is enabled. The use of only a single switching time program for a wide range of applications makes it possible to simplify operation.

See also 5.2.3.2 Time program, Pg. 72

6.3 Suppressing the cycle temperature on time program level

When programming switching times, the specialist can set a system parameter to suppress the respective room or DHW temperature for the cycle.

Function Setting "ON" causes control of the respective circuit to be based on the cycle temperatures stored in the switching cycles.

For the "OFF" setting:

- All cycle temperatures are suppressed during switching time programming
- Nominal room and DHW temperatures arise exclusively depending on daytime room temperature or daytime water heater temperature specification
- All connected wall devices react identically to parameter changes in the central device

6.4 Enabling "Separate Control Mode"

To make operation as easy as possible for most of the applications, a global control mode is set for all heating circuits when supplied. For those rare cases in which a separate control mode is necessary (e.g. for renters and landlords), it must be enabled in the "System Parameters" menu, Control Mode parameter.

Function This parameter determines the operating mode and affects the

- control mode selected with the "Control Mode" key
- daytime temperature selected with the "Daytime Room Temperature" key
- night-time temperature selected with the "Night-Time Room Temperature" key

Enabling 5.2.3.3 Operating mode, Pg. 74

6.5 Switching from SDC to DHC

Language selection occurs after the controller is started. You can then select the controller type:

- SDC (heating controller)

or

- DHC (district heating controller)

"SDC - DHC" appears on the top line. The selection option "SDC" or "DHC" appears at the bottom right. The controller type depends on the relay equipment or the set type/max code.

Switching is only possible with relay equipment for which DHC types exist. This is not the case with any others.

Switching the setting is also possible via a special system parameter.

The type code setting is identical for both versions, i.e. the type code numbers of SDC equipment correspond to those of DHC equipment.

Reducing a controller to a heating circuit expansion via type code (21 or 22) functions only with a presetting to controller type SDC.

6.6 Selection of hydraulic parameter presettings

Each controller type covers a specific hydraulic diagram in its "as supplied" condition. Depending on the configuration variants there is also the possibility of adapting the system by means of further parameter settings to hydraulic diagrams differing from the standard hydraulic system.

With parameter 01 in the "Hydraulics" menu a preselection can be made from the hydraulic schemes collection. The corresponding inputs and outputs are assigned automatically according to the hydraulic diagram and can be altered if necessary. The associated system schematics are available in the hydraulic schemes collection.

See also 5.4 Parameter settings, Pg. 81

6.7 The variable inputs and outputs of device series SDC/DHC 43

Variable inputs The selected functions can be assigned only once and are then no longer callable in other variable inputs. If an input function is absolutely necessary for a corresponding output function with regard to the variable outputs, no selection is possible.

6.8 General functions and their operation

6.8.1 Outside temperature sensing

6.8.1.1 Building type

Function This parameter takes into account the relevant building type by means of various calculation methods for the determination of the outside temperature mean value according to the setting.

Light construction The mean value is obtained over a period of 2 hours.

Application:

Wooden houses, lightweight brick buildings

Medium construction The mean value is obtained over a period of 8 hours.

Application:

Medium-weight masonry in hollow blocks or bricks

Heavy construction The mean value is obtained over a period of 24 hours.

Application:

Heavy masonry in tuff or natural stone

See also 5.4.4 "Direct heating circuit" menu (UNMIXED CIRC), Pg. 92 and 5.2.5 "Direct Heating Circuit" / "Mixed Heating Circuit 1" / "Mixed Heating Circuit 2" menu, Pg. 78

6.8.2 Heating circuit outside temperature assignment

NOTE Function active only when using a second outside sensor!

Function If in the central device a second outdoor sensor (AF2) was connected to a variable input and registered, the heating circuit can be assigned either to the outside sensor 1, 2 or to the mean value of both sensors.

For each outside sensor the following applies:

In case of a defect affecting a sensor, switching to the remaining outside sensor with simultaneous fault indication occurs automatically. In case of a defect affecting both sensor circuits the heating circuit is regulated on the basis of a set heating characteristic curve and heating program corresponding to a fictitious outside temperature of 0°C with regard to the set minimum temperature.

See also 5.2.5 "Direct Heating Circuit" / "Mixed Heating Circuit 1" / "Mixed Heating Circuit 2" menu, Pg. 78

6.8.3 Outside temperature emergency operation value

Function If a connected outside sensor fails during weather condition-controlled operation (sensor short-circuit or interruption), emergency operation takes effect.

Weather condition-based control then adjusts the temperature based on an assumed fixed outside temperature specified via a parameter value.

Designation	Key/Menu	Parameter
Characteristic curve for emergency operation without outside sensor	SYSTEM	29

6.8.4 Outside temperature disable

Function The purpose of outside temperature disable is to prevent the heat generator from starting up above a defined outside temperature.

If several heat generators are controlled though one device (automatic stoker, 2-stage), all stages of the device will be disabled with outside temperature disable.

In the case of cascaded systems with multiple devices, the entry of an outside temperature disable is possible for each central device so that individual levels can be blocked by the outside temperature disable.

6.8.5 Climate zone

Function The climate zone is the coldest outside temperature value to be expected.

For the heat demand coverage, this value is taken as the basis for the design of the heating system.

This parameter defines the corresponding slope value of the heating curve of the heating circuit with regard to the climate zone.

See also 5.2.3 "System Parameters" menu, Pg. 71

6.8.6 Design temperature

Until now, configuration of the heating curve calculation occurred via the values

- Climate zone (T_{ANorm})
- Slope (S)
- Heating system (m value)

Supplemental to the slope, the setting of the design temperature T_{VLNorm} is also possible directly at the controller.

Setting range DESIGN TEMP: Setting range HC_{min} to HC_{max} ($^{\circ}C$)

There is a direct relation between the HEATING CURVE and DESIGN TEMP parameters in the following connection:

$$T_{VLNorm} = (20^{\circ}C - T_{ANorm}) * S + 20^{\circ}C$$

This means that the value of the respective other parameter changes accordingly.

The display for the heating curve adjustment occurs in combination, i.e. the design temperature (bottom right) and the slope (bottom left) are displayed and set in one display. Both flash during adjustment.

The parameter (display above) is still HEATING CURVE.

The jump occurs via the "Direct Heating Circuit" or "Mixed Heating Circuit 1"/"Mixed Heating Circuit 2" menu and the heating curve parameter.

6.8.7 Summer switch-off

NOTE This function is only effective in control mode AUTOMATIC.

Function For higher outside temperatures, normally above 20°C, it does not make sense to keep the heating on in the building. You can thus choose to switch-off heating depending on the outside temperature according to the following criteria:

Outside temperature rise

A switch-off is initiated when the mean outside temperature exceeds the set value.

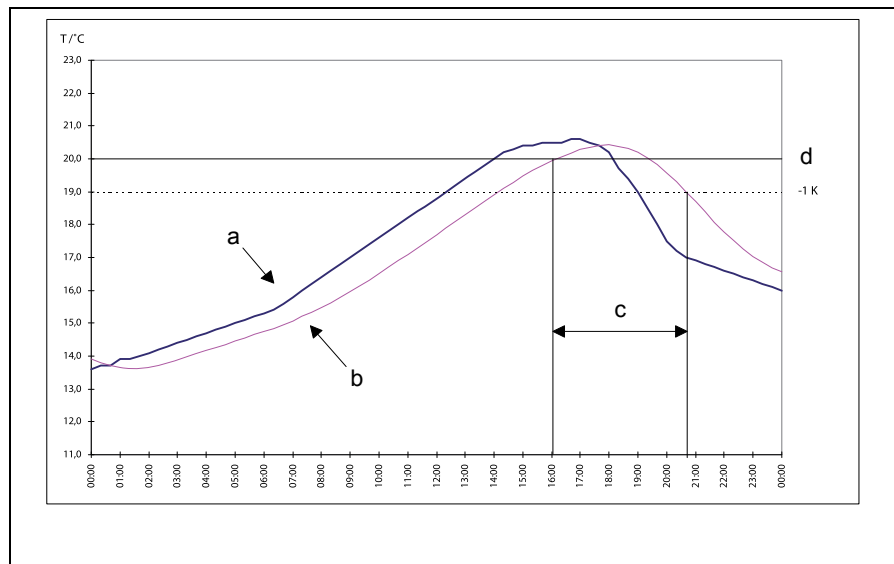

- | | | | |
|---|-----------------------------|---|----------------------|
| a | Current outside temperature | c | Summer switch-off on |
| b | Mean outside temperature | d | Set value |

Cancelling switch-off

The switch-off is cancelled when the current outside temperature drops below the set value by more than 1 K

The summer switch-off function is cancelled:

- in case of an outside sensor defect
- in case frost protection is active

NOTE The HEATING LIMIT parameter can be used to assist the summer switch-off function. This function allows setting non-heating periods on warm days for each individual heating circuit.

In connection with a second outside sensor, the current averaged outside temperature is accepted for summer deactivation if the average value of both sensors is specified during outside sensor assignment.

Active summer deactivation is represented by a beach umbrella symbol in the basic display. In case of separate operation of the heating circuits ("System Parameters" menu, Control Mode parameter) the symbol is not displayed. If two outside sensors are connected and they were assigned to different heating circuits, the symbol is furthermore only displayed if both sensors fulfil the condition for summer de-activation.

See also 5.2.3 "System Parameters" menu, Pg. 71

6.8.8 System frost protection

Function To avoid the freezing of the heating system in switch-off mode, the controller is equipped with electronic frost protection.

Operation without room temperature sensing

If the outside temperature (current value) drops below the set limit, heating is turned on again. Heating is interrupted if the outside temperature exceeds the set limit by 1 K.

Operation with room temperature sensing

As long as the room temperature is above the set room setpoint, the heating circuit pumps are running if outside temperatures are below the set freezing limit.

If the room temperature drops below the set room setpoint, heating is resumed.

Switch-off occurs again when the room temperature exceeds the set room setpoint by 1 K. If at this moment the outside temperature is still below the set freezing limit, only the heating circuit pumps remain active.

NOTE If not every heating circuit is operated with room temperature sensing, different frost protection functions can be assigned to the individual heating circuits. If, for example, a mixed heating circuit is operated with room temperature sensing and the direct heating circuit is not, the latter's heating curve and room temperature setpoint are to be set as low as possible.

In connection with a second outside sensor, the frost protection function is activated as soon as one of the two outside temperatures drops below the frost protection limit. In case of a faulty outside sensor, frost protection is activated continuously.

▲ ATTENTION

In connection with a room sensor, the thermostat function is not active with active frost protection.

See also 5.2.3 "System Parameters" menu, Pg. 71

Cycle operation

The frost protection function is activated as soon as the temperature drops below the set frost protection limit ("System Parameters" menu, parameter 05). The frost protection function becomes effective when frost protection is active and there is no demand by the heating circuit.

- With the frost protection setting "cycle operation", there is no continuous demand for the heat generator, in contrast to continuous operation.
- With system frost protection active, the heating circuit pumps are switched on and the mixed heating circuit valves are closed.
- As long as the measured flow temperature of the mixed heating circuits or the heat generator temperature in the direct heating circuit, respectively, does not drop below the current setpoint room temperature (RT_{Frost} or RT_{Night}), no demand value is forwarded to the heat generator.
- When the flow temperature drops below the current setpoint room temperature, heating is activated.
- Once the setpoint flow temperature has reached the setpoint room temperature and the set time ("System Parameters" menu, parameter 19) has passed, the demand value to the heat generator is retracted and the mixed heating circuit valve closes while the pumps continue running.
- If no data are detected from the outside sensor (e.g. because the sensor is defective), control strategy is executed via the parameter 29 in the "System" menu.
- The set minimum and maximum limits are taken into account while heating.
- When the heat generator is activated, the set start-up protection conditions of the heat generator are applied. This can mean that the heating circuit pumps are switched off temporarily.

Frost protection function in case of heat generator fault

If system malfunction message 30-3 or 31-3 occurs (e.g. switch-on failure of the burner(s) due to fuel shortage or burner malfunction), priority pump switch-off functions such as boiler start-up protection, DHW priority etc. are disabled if frost protection is active.

The heating water circulated in the heating circuits adopts the overall mean room temperature and reduces or delays any freezing.

6.8.9 Pump forced operation

Function With this function activated, all the pumps are switched on every day for approx. 20 seconds to protect against blocking owing to corrosion in case of long switch-off periods (> 24 h) and the mixed heating circuit is opened temporarily during this period.

See also 5.2.3 "System Parameters" menu, Pg. 71

7 Hydraulic Components

7.1 Heat generator: Boiler

7.1.1 Heat generator start-up protection

The start-up protection function prevents condensate building up when heating up while cold.

Function There are three different modes of start-up protection that can be set:

Unlimited start-up protection

When the temperature in the heat generator drops to 2 K below the set minimal limit, all heating circuits are separated, at the water side, from the heat generator (pumps = off, mixed heating circuit = closed) to pass through the dew point as quickly as possible. The heating circuits are enabled as soon as the temperature in the heat generator has reached the minimum limit plus half of the burner switching differential 1.

Start-up protection controlled by weather conditions

The heating-up characteristic is the same as for unlimited start-up protection, meaning the heat generator remains in operation until the set minimum temperature plus half of burner switching differential 1 is exceeded. Below the minimum temperature, the pumps remain switched off and the mixed heating circuit closed.

Once the heat generator has been switched off, the start-up protection becomes active again only when the heat generator temperature drops below the weather-responsive demand value (acc. to heating curve setting and nominal room setting). The subsequent heating-up follows the same scheme as for unlimited start-up protection. The result is a mean value based on the difference between the weather condition-controlled demand value and the minimum limit setting. This mean value will be significantly lower than the value set for a heat generator operated with a permanent minimum temperature limit.

Separate start-up protection for heat generator and heating circuits

This function allows separation of the temperatures for switching on the burner and switching off the heating circuit when the boiler temperature falls below the boiler minimum temperature limit.

See also 5.2.4 "DHW" menu, pg. 77

7.1.2 Heat generator minimum temperature limit

Function To protect the heat generator from condensation formation, the minimum temperature limit specified by the heat generator manufacturer is to be set.

The heat generator switches on when the temperature falls below the set value, while it switches off when the set value plus the burner switching differential is exceeded. During heating, the set limit value is not undershot.

The setting of this parameter is used solely for the response of the heat generator (burner) to the set minimum temperature ($KT_{\min-WEZ}$). The function for the heat generator remains unchanged.

The mode of operation of the set limit is defined via the "Heat Generator" menu, heat generator start-up protection parameter.

There are three different modes of operation for the minimum temperature limit:

Minimum limit based on demand

As long as there is no demand from heating or hot water, the boiler remains switched off. The minimum limit is disabled. The burner is switched on and the heat generator is heated up to the set minimum temperature limit as soon as the temperature in the heat generator drops below the fixed heat generator frost protection temperature of +5°C.

Conditional minimum limit

The boiler minimum temperature acts as the lower limit, which will be maintained even if there is no demand. The boiler is switched off only if summer switch-off is active.

Unlimited minimum limit

The boiler temperature is maintained according to the set minimum temperature, independent of demands or deactivating control modes.

See also 5.2.4 "DHW" menu, pg. 77

7.1.3 Maximum temperature limit heat generator

Function In order to protect the heat generator against overheating, the controller is equipped with an electronic maximum temperature limit. It shuts off the burner if the temperature in the heat generator exceeds the limit value.

The burner is switched on again if the temperature in the heat generator falls below the limit value by half of the burner switching differential plus 2 K.

See also 5.2.4 "DHW" menu, pg. 77

7.1.4 Heating circuits minimum temperature limit

- If the boiler temperature BT_{actual} is less than or equal to the parameter setting 27 ($BT_{\text{min}} - HC$), the heating circuit pumps switch off (DHCP, SFP, MCP). The mixed heating circuit valves close.
- If BT_{actual} is greater than $BT_{\text{min}} - HC + SC_{\text{min}} - HC$, the heating circuit pumps and mixed heating circuit valves are enabled again.

7.1.5 Heat generator sensor control mode

Function There are various ways in which the heat generator can react to a malfunction of the heat generator sensor:

Burner switch-off in case of a faulty heat generator sensor

A fault message appears in case of a short-circuit or interruption of the sensor; the burner will be switched off.

External burner switch-off

In case of the interruption of the sensor the burner is switched off without a fault message. It is used, for example, for external burner switch-off or enabling in case of the interruption of the heat generator sensor.

▲ ATTENTION

Only Ag (hard silver), Au (gold) or Ni (nickel) are to be used for the contacts.

In case of a sensor short-circuit a relevant fault message appears and the burner is blocked.

Burner enabling in case of a faulty heat generator sensor

In case of a sensor short-circuit or interruption, a fault message appears upon simultaneous unlimited enabling of the burner. The control of the heat generator is carried out only manually by means of the mechanical boiler temperature controller (boiler thermostat) on the boiler panel according to the set value.

▲ ATTENTION

Activation of this setting is only permissible if an electromagnetic boiler temperature controller is connected in series with the burner phase and the boiler temperature is thus limited by this boiler temperature controller. Otherwise, there is the danger of boiler overheating.

See also 5.4.6 "Heat generator" menu (HEAT GENER., pg. 99)

7.1.6 Minimum burner runtime

Function This function extends the burner runtimes and reduces the standby losses. After starting the burner, a minimum of the set time must elapse before the burner is deactivated again (regardless of the temperature increase).

NOTE If the temperature in the heat generator exceeds the set heat generator maximum temperature limit, the minimum burner runtime is stopped and the burner is switched off in advance.

See also 5.4.6 "Heat generator" menu (HEAT GENER., pg. 99)

7.1.7 Switching: Multi-stage heat generator/Switching differential

Function The control unit offers independently adjustable switching differentials with reference to the same setpoint.

Switching differential I Switching differential I controls the heat generator capacity required according to load and demand by switching on and off the stage required for the actual heat demand within the set range. Switching on and off is initiated symmetrically to the setpoint within half of the absolute value of the switching differential.

Switching differential II Switching differential II (only two-stage heat generator and heat generator 2 x single stage) determines how many stages are required to meet the actual heat demand (partial load - stage I, full load - stage II). This switching differential is overlaid symmetrically on switching differential I and must always be set to higher values.

NOTE In cascade mode, this setting would be superseded by the cascade setting and is therefore not available.

Mode of operation with switching differential II

- When the heat generator temperature is below switching differential II, stage I is switched on without delay. Stage II is enabled after stage II delay has passed (see "Heat Generator" menu).
- Stage II is switched off as soon as the heat generator reaches the setpoint temperature plus half of switching differential I.
- Stage II is switched on again as soon as the heat generator undershoots the setpoint temperature minus half of switching differential I.
- Stage I is switched off when the heat generator temperature exceeds the set nominal value plus half of switching differential II.

In some cases it can be expedient to apply a fixed delay for further heat generators, e.g. if the heat generators use different energy sources. This fixed time delay can be set with parameter 39 in the Heat Generator menu. In this case, the settings of parameter 10 in the Heat Generator menu or the parameter 02 in

the Cascading menu are no longer accessible or will be overwritten.

Combined operation for 2-stage heat generators

- As long as just one stage can meet the heat demand (stage II inactive), stage I is switched according to switching differential I.
- As soon as stage 2 is needed to meet the heat demand, switching differential I takes over the switching on and off of stage II and switching differential II takes over the switching of stage I.

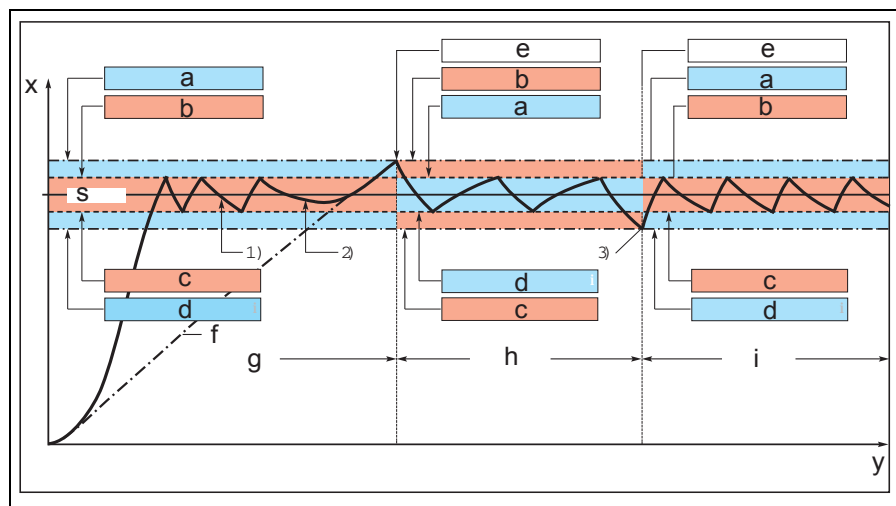

- | | | | |
|----|--|---|--|
| a | Switch-off level stage I | g | Area 1 high use (start-up), coverage of heating demand at full load (burner stages I and II) |
| b | Switch-off level stage II | h | Area 2 low use, coverage of heat demand with partial load (burner stage I only) |
| c | Switch-on level stage II | i | Area 3 increased use, coverage of heating demand at full load (both burner stages) |
| d | Switch-on level stage I | x | Boiler temperature |
| e | Swap of switching differential | y | Time |
| f | Theoretical progression with stage I alone | | |
| 1) | Temperature drop becomes slower after every switch-off of stage II, as stage I provides support. | | |
| 2) | Switch-on level stage II is no longer reached, temperature is reached from stage I. | | |

- 3) Temperature drops due to increased heat demand under switch-on level stage II.

Time delay stage II Enabling of stage II (full load stage) is controlled not only by the switching differentials but also by a time delay. In this way, stage II remains disabled for the set delay so that stage I will be active longer. This function is only effective during the start-up phase (when there is demand for both stages). When stage I is in base-load operation and stage II in adjustment operation (covering excess heat demand), the latter is switched on immediately when the demand arises.

NOTE In cascade mode, this setting would be superseded by the cascade setting and is therefore not available.

Enabling mode stage II The parameter "Enabling mode full-load stage" allows changing the effect of a time delay stage II setting **during** the start-up phase **below** the heat generator minimum temperature limit.

Unlimited enable during start-up relief

Both stages are in unlimited operating during start-up.

Time-out during start-up relief

Stage II is switched on after the set time delay acc. to time delay stage II:

NOTE In cascade mode, this setting would be superseded by the cascade setting and is therefore not available.

Hot-water loading mode stage II The function "hot-water loading mode stage 1-2" allows defining of the loading mode for the hot-water heater with 2-stage or 2 x single-stage heat generators. The following options are available:

- 2-stage hot-water circuit loading with delayed enabling of stage II acc. to time delay stage II
- Unlimited 2-stage hot-water circuit loading
- Hot-water loading with stage I only; stage II disabled

NOTE In cascade mode, this setting would be superseded by the cascade setting and is therefore not available.

See also 5.4.6 "Heat generator" menu (HEAT GENER., pg. 99)

Outside temperature disable When the actual outside temperature exceeds the set limit, all demand on the heat generator is disabled within a device. The heating circuits continue operating, but the heat generator will not be switched on. The preset minimum burner running times are fulfilled. Only when the outside temperature drops to the outside temperature disable level minus 2 K is the heat generator enabled again. If several heat generators are controlled through one device (condensing burners, 2-stage burners), all stages of the device will be disabled.

NOTE If a fault occurs at a heat generator, all outside temperature disables in the system are cancelled.

Base load offset This setting becomes effective only if several heat generators are operated in cascade mode.

Burner stages operating as base load are given a higher setpoint temperature than the modulating stage, which is switched on last. This higher value is composed of the current setpoint temperature plus the set base load offset. If several heat generators are switched through one control device, the setting applies to every heat generator.

Heat generator reset With 2-stage heat generators, the counters for operating hours and burner starts (see Parameter settings 5.4, pg. 81) can be reset separately for stage 1 (ST-1) and stage 2 (ST-2).

Resetting

With the reset indicator flashing (RESET), the reset-ready indicator (SET) will flash when the input button is pressed briefly. A reset will be performed when the input button is pressed for approx. 5 seconds.

After the parameter values are reset, a return to the first parameter in the "Heat Generator" menu occurs.

7.1.8 Operation for modulating burners

Modulating burners are controlled in a way similar to mixed heating circuit control, through a PI control algorithm, since in this case an actuator integrated in the burner regulates the air/fuel ratio according to the heating power. However, in contrast to the control of conventional burners, operation of modulating burners is subject to the following criteria:

Switching differential In contrast to conventional ON/OFF burner control systems with their switching differentials symmetrical around the respective setpoint temperature, the switching differential for modulating burners is an asymmetric interval with the switch-on level always 1 K below the setpoint temperature. This offers the advantage that, in case of another possible overshoot through the P part, the burner is not switched off, because the switch-off point lies **above** the setpoint by a wider margin than the switch-on point is **below** the setpoint (overshoot reserve). Also, when the heat demand is low (especially in the low-load area) the temperature will drop only slightly since the burner is switched on again as soon as there is a deviation of more than 1 K.

Example:

Set nominal temperature = 50 K

Switching differential = 6 K

Switch-on at $(50^{\circ}\text{C} - 1\text{ K}) = 49^{\circ}\text{C}$

Switch-off at $(49^{\circ}\text{C} + 6\text{ K}) = 55^{\circ}\text{C}$

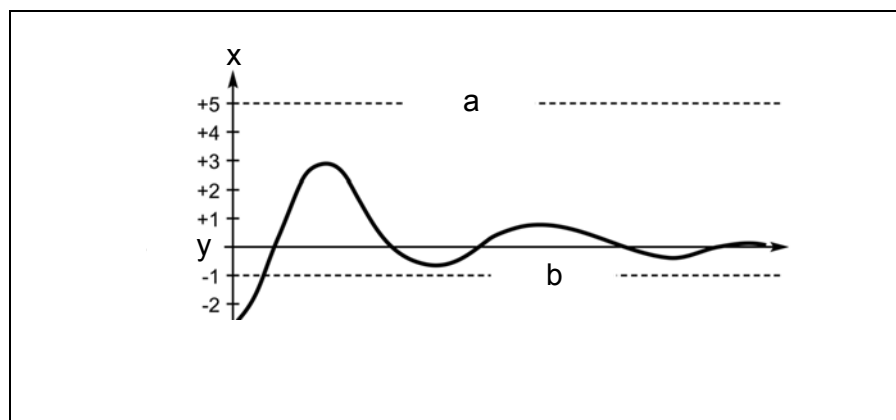

a	Switch-off level	x	Deviation (K)
b	Switch-on level	y	Setpoint value

Activation of modulation	The modulating burner stage is activated when the heat generator temperature has dropped below the set nominal temperature by more than 1 K. The burner is enabled through the burner relay. As soon as the heat generator temperature crosses the switch-off level the burner is deactivated, in contrast to the mixed heating circuit parameters.
Adjustment	Adjustment to the setpoint temperature is realised through the conventional 2-point output (activating the burner) and an additional 3-point output for modulating the actuator in the burner. The temperature is registered by the heat generator sensor. In contrast to mixed heating circuit control, no end position function is assigned to this actuator. The control algorithm is running continuously.
Minimum burner run time	The burner remains in operation for the duration of the set minimum burner runtime irregardless of temperature-based switch-off conditions.
Minimum and maximum temperature limit	If the heat generator maximum temperature is exceeded or the heat generator minimum temperature is undershot, the same functions apply as with conventional heat generators.

7.1.9 Modulation of P part (Xp)

Function The proportional part Xp defines how a step change of the setpoint effects a change of the corresponding actuator according to the new setpoint.

Example:

With a max. heat generator temperature of 70°C, the actuator in the modulating burner must cover a temperature differential of 50 K (starting from a room temperature of 20°C). This corresponds to a control deviation of 100%. The set value is calculated as follows:

$$X_p (\%)/K \times 50 K = 100\% \text{ or } X_p = 2\%/K$$

7.1.10 Modulation of sample time Ta

The sample time is a controller-internal quantity which defines the time interval between two subsequent actuator pulses in the presence of a control deviation. Shorter sample times allow finer adjustments.

7.1.11 Modulation of integral action time T_n

The integral part (= adjustment time) determines the dynamic behaviour of the controller and thus the time required by the controller to adjust for the actual control deviation. The adjustment time is independent of the amount of deviation.

7.1.12 Modulation of runtime

This function allows adjusting the actuator, with regard to its finite running time, to the control characteristics, meaning that actuators with different runtimes react to the same deviation by readjusting by the same amount through adapting the action times. The integral action time T_n remains unchanged in this. However, care must be taken that the latter must always exceed the runtime of the respective actuator.

7.1.13 Modulation of start time

The start time parameter determines the length of the start-up phase in modulation mode so that a stable start-up is ensured. As soon as the set start time has expired, the modulation switches to its normal control characteristics defined by the modulation parameters.

7.1.14 Modulation of start power

The start power parameter determines a percentage setting for part of the modulation runtime during the start-up phase. With a setting of 0% the actuator valve remains always closed. As soon as the set start time has expired, the modulation switches to its normal control characteristics defined by the modulation parameters.

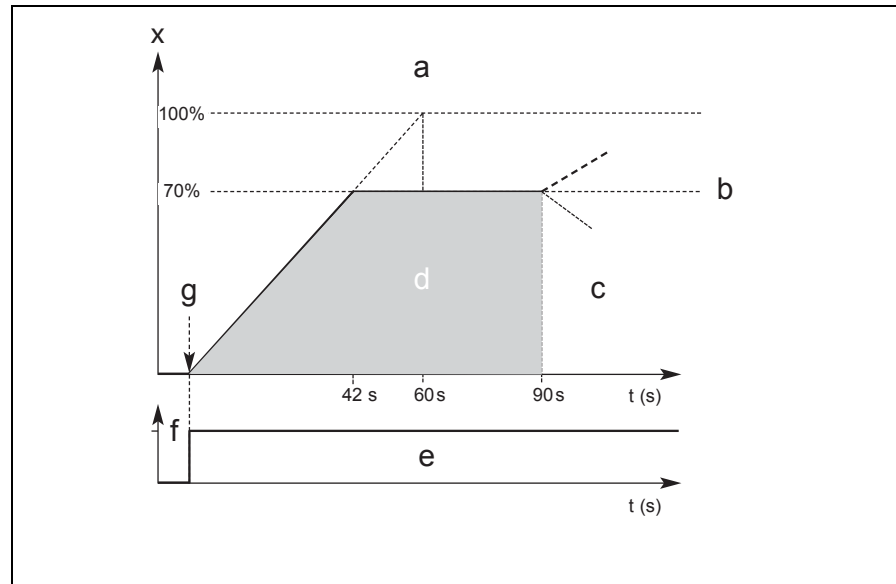

- | | | | |
|---|---|---|-------------------|
| a | Modulation | e | Base load |
| b | Upward/downward modulation depending on the control deviation | f | On |
| c | Adjustment operation | g | Start |
| d | Start-up phase | x | Starting load (%) |

7.1.15 OpenTherm

- **OpenTherm** is the plug & play bus system!
- OpenTherm has developed into a standard in heating technology. Many gas condensing boilers today feature an OpenTherm connection or manufacturers offer an optional OpenTherm interface.
- The OpenTherm bus uses simple bi-directional 2-wire communication between the heat generator and the room controller.

The simple **OpenTherm** 2-wire bus allows bi-directional communication between the room controller and heat generator, i.e. data exchange occurs in both directions.

In use, the simplicity of the **OpenTherm** system is key.

The boiler setpoint is transmitted from the SDC controller to the automatic stokers via **OpenTherm**, and feedback of the boiler actual value occurs from the automatic stokers (in addition to the hot-water actual and outside temperature and fault messages, if appropriate).

Setting in the "Heat Generator" menu, parameter 1, setting 5 (automatically detected when a heat exchanger bus (**OpenTherm**) is connected (AUTOSSET), however).

If the **OpenTherm** function is active, the boiler minimum limit is automatically set to 5°C.

To use the **OpenTherm** function, the boiler must have an **OpenTherm logo**.

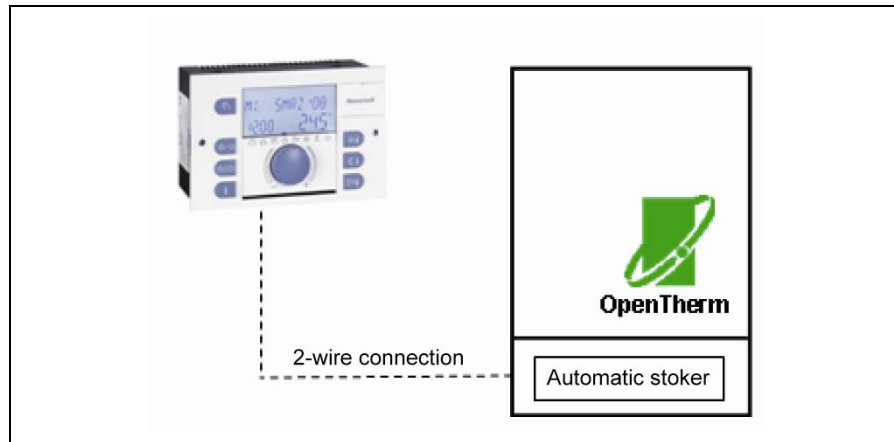

Electrical connection Terminals 37/38 on SDC

7.1.16 Use of boiler sensor 2

Function Two single-stage heat generators

For sensing of the temperature in the second heat generator with double boilers or two single-stage heat generators (see "Heat Generator" menu, parameter 1 boiler type = 3)

Two measuring points in the combustion chamber

In order to reduce standby losses by increasing the burner runtimes. With automatic sensor switching between boiler sensor 1 and 2 after the burner switching cycle, the On signal for the burner will be determined by the upper sensor (BS1) and the Off signal by the lower sensor (BS2) based on the specified demand value and switching differential(s).

7.1.17 External heat generator cut-off

Function If the assigned variable input is short circuited, there will be a permanent deactivation of the heat generator. It is cancelled again once the short-circuit is remedied.

▲ ATTENTION

This function is meant exclusively for external override signals and not for safety switch off!

7.1.18 Heat generator forced discharge

Function When the temperature in the heat generator exceeds the set maximum temperature limit, any excess energy is dissipated into circuits downstream. This function applies to all controllers on the bus system.

Set values **OFF**

No heat dissipation

Dissipation into hot-water tank

With provision tanks only

▲ ATTENTION

Thermal mixing valve at water heater outlet obligatory because of scalding hazard.

Discharge to heating circuits

Any excess heat is dissipated into the heating circuits. The set maximum temperature is not exceeded here. The intended room temperature may be exceeded for short periods. If the respective circuits are equipped with room stations, the thermostat function should be activated.

▲ ATTENTION

For floor heating a contact thermostat must be installed to control forced switch-off of the pumps.

Dissipation into buffer tank

Any excess heat is dissipated into the buffer tank, without exceeding the set maximum temperature.

7.1.19 Exhaust gas temperature monitoring

NOTE Only if parameter 8 variable input 1 = 16 - Flue gas sensor set in the "Hydraulics" menu.

A flue gas sensor can only be connected to the variable sensor input VI 1. Due to the high temperatures involved, a PT 1000 sensor is used for this purpose. The control device automatically evaluates the sensor data, which are different from the data supplied by the standard sensors.

When a sensor fault is detected with the flue gas sensor active, and if flue gas monitoring was set for temporary disable or permanent inhibit (safety functions), there will be a heat generator switch-off in addition to the malfunction message.

Function This function controls the necessary measures in case the flue gas temperature exceeds the allowable limit.

Display of flue gas temperature only

No follow-up function; the actual flue gas temperature is displayed in the Information display.

Heat generator lock if limit value is exceeded for set time

When the temperature limit is exceeded the heat generator is disabled for the set time and a fault message is sent.

Heat generator lock if limit value is exceeded

When the temperature limit is exceeded the heat generator is disabled and inhibited permanently. It can only be unlocked by a reset in the "Fault Messages" menu.

Flue gas temperature limit With the parameter set accordingly, the allowable temperature limit for the flue gas, according to specifications of the heat generator manufacturer, has to be entered as the reference value for the follow-up functions described above.

Recommended setting:

Nominal flue gas temp. acc. to manufacturer data, plus 10 - 20 K

See also 5.4.6 "Heat generator" menu (HEAT GENER., Pg. 99)

7.1.20 Burner counter mode

The system features two operating hour and burner start-up counters (one each for the 1st and 2nd stages). The display is output on the information level of the counter.

The function of the operating hour counter can be set via a parameter.

OFF The operating hour counter is deactivated.

AUTO If an operating hour counter is connected to the corresponding inputs of the controller (operating hour counter inputs), this value is called upon for counting.

Otherwise, theoretical values are determined and included (switching times and switching frequency of the outputs).

If a signal was detected once at the operating hour counter input and the operating hour counter signal does not follow the boiler demand, a fault message occurs.

Feedback only Functions such as AUTO, however a theoretical value is not determined. Only signals from burners are processed.

Free counter The operating hour counter input can be used as a free counting input. A fault message does not arise if a signal is missing.

NOTE Since the counter values are only stored in the permanent data memory once per day, counter values of the current day could be lost in case of a power failure.

Returning The operating hours and start-ups can be reset separately for stage 1 and stage 2 via two parameters in the "Heat Generator" menu.

7.2 Heat generation, heat exchanger, district heating

Function The heat exchanger control assures that the right flow temperature is provided for all heating demands. The setpoint for the heat exchanger's secondary flow temperature is the maximum selection of all the required flow setpoints. An increase is to be entered under parameter 01.

Parameter	Designation	Range	Presetting	Step	Unit
01	Increase	-10 ... 50	0	0,5	K

The setpoint for the secondary flow temperature has a maximum limit through code 02.

There is a fixed minimum limit of $10^{\circ}\text{C} < 10^{\circ}\text{C}$, corresponding to the functionality of the return interval flushing.

The parallel shift is valid only if there is a demand higher than 15°C.

Parameter	Designation	Range	Presetting	Step	Unit
02	Max. flow temp. setpoint	10 ... 130	90	0.5	°C

7.2.1 On/Off operation of the district heating valve

To always ensure a minimum flow so that the heat meter can work precisely, pure on/off switching is provided in low load mode. Code 03 is suitable for this function as shown in the following diagram.

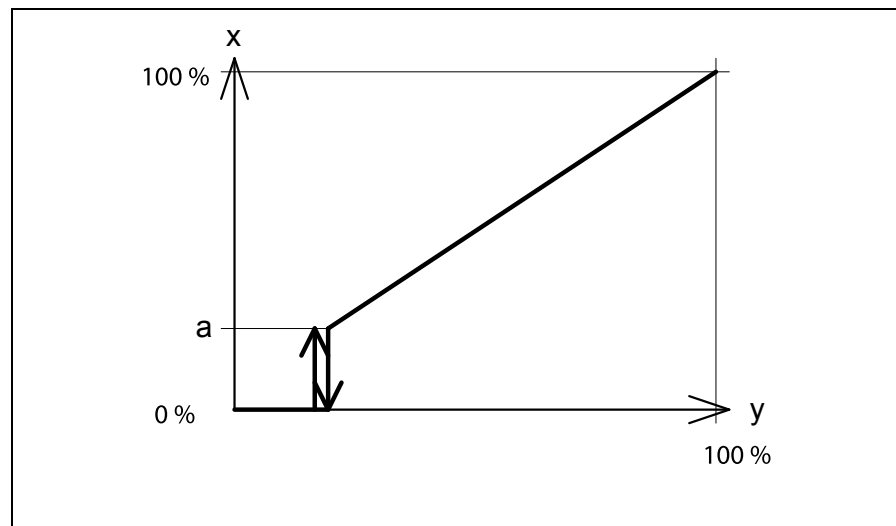

a Minimum travel

y Controller output

x Valve travel

Parameter	Designation	Range	Presetting	Step	Unit
03	Minimum travel	0 ... 50	10	1	%

Should the secondary flow temperature controller output fall below the settable minimum travel in % (code 03), two-step operation begins and the valve is closed. The valve remains closed until the internal controller output reaches 10% again. If a 10% controller output is reached, the valve opens again to the

minimum travel. If the controller output drops below 10% again, the valve closes again and the cycle starts from the beginning.

This means that whenever there are demands of up to 10% on the heat generator the valve is operated in On/Off mode and the secondary flow temperature is controlled this way.

7.2.2 Continuous heat exchanger valve control

If the output of the secondary flow temperature controller rises above 10%, the PI controller controls the secondary flow temperature according to the required setpoint within its limits. The "Proportional Range", "Adjustment Time" and "Motor Runtime" control parameters can be set in parameters 04 and 05.

Parameter	Designation	Range	Presetting	Step	Unit
04	S gain	0,1 ... 30	5	0.1	%/K
05	Adjustment time 0 = pure P controller	0 ... 60	3	1	min
06	Runtime of district heating valve	10 ... 1800	120	1	s

7.2.3 District heating return temperature limit

Many district heating companies require min. volume flows in their networks. This can be achieved through a high temperature differential between the flow and return.

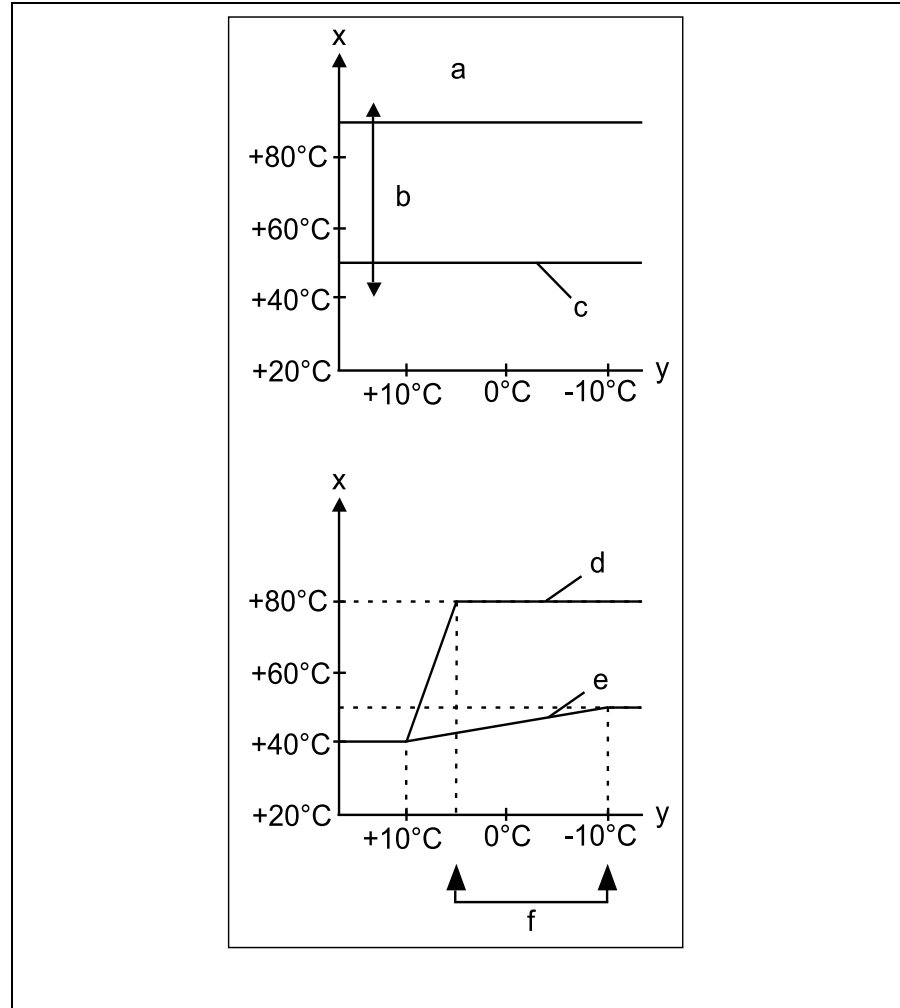

- | | | | |
|---|-----------------------------|---|--|
| a | Example 1 (factory setting) | e | Example 4 |
| b | Return temperature limit | f | Starting points of the flexible return temperature limit in examples 3 and 4 |
| c | Example 2 | x | Return setpoint |
| d | Example 3 | y | Outside temperature |

By means of district heating return temperature limitation the required temperature difference is assured. The maximum limit can either be a fixed value limitation or a flexible limitation according to the outside temperature. A fixed value limit of e.g. 50°C means that the district heating return temperature will not exceed this value over the entire outside temperature range.

In case of higher outside temperatures it is desirable that the maximum limit can be reduced, i.e. flexible district heating return temperature limitation is to be adopted. Through the assignment to the respective outside temperature, the lowest possible district heating return temperature and thus good heat exploitation are obtained.

The values for the maximum limitation of the district heating return temperature (code 08) and the starting point of the flexible district heating return temperature limitation (code 09) can be set for the operation with heating circuits. The flexible return temperature limitation can be switched off by selecting 10°C as the starting point.

+40°C is set as the bottom return setpoint for the flexible return temperature limit.

If the maximum limit is exceeded, a second PI controller intervenes with the same parameters as in the secondary control (heating temperature control).

Return temperature limit	Starting point of the flexible return temperature limitation
Example 1: 90°C	10°C Factory setting
Example 2: 50°C	10°C Fixed value limit
Example 3: 80°C	5°C
Example 4: 50°C	-10°C

Besides return temperature limitation either volume flow limit or thermal output limit can also be set for this controller. The selection of these functions is described below in parameter 11.

Parameter	Designation	Range	Pre-setting	Step	Unit
08	Max. return setpoint	0 ... 100	90	0.5	°C
09	Starting point of the flexible district heating return temperature	Off -40 ... +10	Off	0.5	°C
11	Return limit 0 = Temperature 1 = Volume flow and temperature 2 = Heat output and temperature	0 / 1 / 2	0	-	-

7.2.4 Return temperature limit for hot-water loading

In the case of hot-water loading a special constant return setpoint applies. It is valid only if the hot-water loading pump is operating. The return setpoint is to be set with parameter 10.

Parameter	Designation	Range	Pre-setting	Step	Unit
10	Hot-water circuit loading: Target return	40 ... 100	90	0.5	°C

The return temperature for hot water loading and simultaneously enabled legionella function can be increased with the value of parameter 16. By doing so, the requirement of municipal utilities

allowing an increased return temperature for normal hot water loading and simultaneous legionella function, is met.

7.2.5 Hot-water pre-regulator with district heating systems

The hot-water pre-control function is necessary for the controlled filling of hot water storage tanks with layered loading from the district heating network. Generally, such loading is carried out through a separate heat exchanger.

The function is activated via a new setting in the "Hydraulics" menu, parameters 03 and 04.

Function number: 30

In the parameter tree for the heating circuits, parameters 14, 15, 18, 19, 20, 21 and 22 are available. With the return flow limit activated, parameter 17 is displayed, too.

Display With the FLOW display, the symbol WW for hot-water pre-mixing is displayed to the lower left.

When the pump status is displayed, the string DEMAND is displayed instead of the control mode.

When the hot-water pre-control is active, the respective mixed heating circuit cannot be used as a heating circuit anymore.

When the hot-water pre-control is active, the request for hot-water loading is not sent directly to the energy management unit (and further to the district heating valve), but instead to the hot-water pre-control.

The hot-water pre-control forwards the setpoint, taking into account the parameter-defined offset, to energy management and adjusts to the nominal value, which was received from hot-water loading, at the mixed heating circuit actuator.

Any parameter-defined return flow limiter sensor (setting 7/8 at the variable input) acts according to its set function on the actuator of the hot-water pre-control.

The switching behaviour of the tank loading pump is described in a separate demand.

The hot-water pre-control must be activated in the same control device as the associated hot-water loading.

The mixed heating circuit minimum and maximum limits are not adjustable and have no effect.

The run-down time of the mixed heating circuit pump runs parallel with the tank loading pump extended running time.

The boiler parallel shift of the tank loading pump (parameter) acts on the mixed heating circuit demand.

The boiler parallel shift of mixed heating circuits acts on the heat generator, provided the tank loading pump control mode has not been set to "external storage tank".

The optional return flow limit acts on the flow mixture according to the setting.

The hot-water pre-control acts only on hot-water loading configured in the same device.

7.2.6 Mode of operation: Hot-water pre-control

When operating in combination with hot-water pre-control, parameter 08 (tank drainage protection) does not act directly on the heat generator, but on the hot-water pre-control.

Parameter 08 is always adjustable for function with pre-mixer. Here, the "OFF" and "ON" settings have different effects, which are described in the following.

Function With the setting "OFF", there will be no start-up protection through the hot-water pre-control. The tank loading pump is switched on without any delay.

With the setting "ON", the tank loading pump is switched on only when the flow sensor detects that the hot-water setpoint temperature + ½ switching difference hot water (without offset) is reached:

- $HWPC_{setpoint} = WH_{setpoint} + P09(HW)$
- SLP = ON if $HWPC_{actual} \geq HW_{setpoint} + \frac{1}{2}SD_{HW}$
- SLP = OFF if $HWPC_{actual} \leq HW_{setpoint}$

Legend:

$HWPC_{setpoint}$ = Actual temperature at flow sensor "hot-water pre-control"

$HW_{setpoint}$ = Hot-water setpoint temperature

$P09(HW)$ = Value of parameter 09 (hot-water loading temperature offset)

SD_{HW} = Switching difference hot water

Both pumps (tank loading pump and hot-water pre-control) switch off after completion of a hot-water circuit loading, taking into account their extended running times. If they are to switch off simultaneously, identical extended running times must be selected for them.

7.2.7 Quick hot-water control

For monetary reasons, hot-water tanks are not used in many district heating systems, especially in Eastern Europe. The hot-water setpoint temperature is held in a closed loop pipeline here (see hydraulic example).

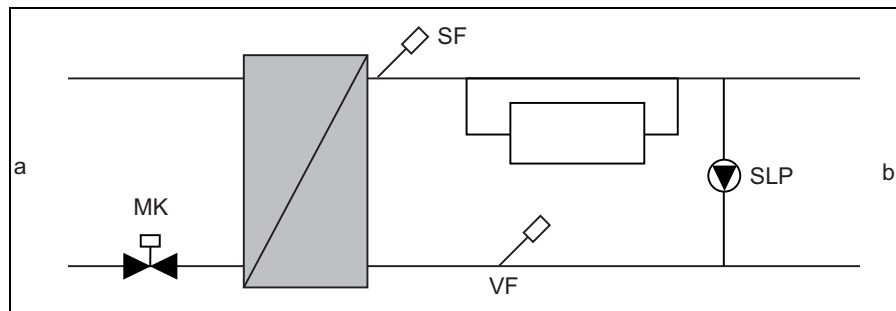

a Flow from closed loop pipeline

b Draw-off points

New parameters

- Minimum spread between the tank sensor and the return sensor from which an offset at the valve is given (see "Mixed Heating Circuit 1"/"Mixed Heating Circuit 2" menu, parameter 39)
- Additional value for offset in %/K deviation (valve starting point for controller) (see "Mixed Heating Circuit 1"/"Mixed Heating Circuit 2" menu, parameter 40)

- Activation** ► Set "quick hot-water control" in the "Hydraulics" menu, parameters 03 and 04 (MC-1/MC-2), set value 39.

The tank loading pump is operated via the tank loading pump output on the controller. The mixed heating circuit pump output switches together with the tank loading pump.

The OPEN and CLOSED outputs of the assigned mixed heating circuit are provided fixed to actuator operation.

The mixed heating circuit 1 flow sensor is automatically assigned as a return sensor.

The mixed heating circuit pump runs continuously except in the STANDBY and HOLIDAY control modes.

With quick hot-water control, parallel operation is generally dominant.

The control valve is operated via two relay outputs. The valve continually adjusts the hot-water setpoint temperature at the strap-on flow sensor (no hysteresis).

The cycle time of the control unit must be less than or equal to 3 sec. Normally, a mixed valve with a runtime of 30 to 60 sec. is used.

- Opening offset** Attach a return sensor so that the mixing valve responds to the varying draw-off behaviour. A conclusion is made based on the quantity drawn off via the temperature differential, and the valve is charged proportionally accordingly.

If the temperature spread between the tank sensor and the return sensor is greater than the set minimum spread, you can assume that water is being drawn off. In this case, give the valve an offset that anticipates down times and thus prevents heavy cycling of the mixing valve.

The value to be added is dynamic and is yielded from the temperature differential and the set parameter value (% based on K deviation).

- Set value**
- Offset 0 - 100%
 - Default value 0%: Represents the valve start-up value (degree of opening) in %. It functions as an offset to the current valve position (0% means no accessing of the valve)
 - DT_{\min} : 2 ... 20 K, factory value: 5 K

In case of a defect, the tank sensor or flow sensor switches off to prevent scalding.

If hot-water loading is not activated, there is no setpoint for the mixed heating circuit. The setpoint for the mixed heating circuit is mandatory.

7.2.8 Mode of operation of hot-water control mode "external operation"

If the energy supply for hot-water loading is not provided through the district heating valve, no hot-water demand may be sent to the heat generator. The following setting needs to be selected for this case:

"Hot Water Circuit" menu, parameter 07 ("Hot-Water Circuit" control mode) = 7 (external operation)

- Function**
- The hot-water pre-control is part of the hot-water loading. Consequently, the request from storage control is forwarded to the hot-water pre-control, which acts according to its function.
- In the "Hot-Water Circuit" "External Operation" control mode, the setpoint value from the hot-water pre-control is not forwarded to the energy management unit (or the district heating valve).

7.2.9 Conditional parallel operation for mixed heating circuits

This function is only realised for district heating controllers.

Additional setting in the "Hot Water" menu, parameter 07 ("Hot Water Circuit" control mode) = 8 (priority with enabling of mixed heating circuit control operation)

Function Function as for hot-water priority operation (setting 2), with the difference that mixed heating circuits (mixed heating circuit control, constant control, fixed-value control) can still adjust to their setpoint. During an active hot-water loading, the heating circuits do post a setpoint value to energy management. Mixed heating circuits must operate at the temperature required by the hot-water demand. Direct heating circuits remain switched off. Hot-water loading with priority operation in the system has priority. The mixed heating circuits must shut in this case.

7.2.10 Circulation pump control mode

During service water loading, it should be possible to switch off the circulation pump.

Setting New parameter: "Hot Water Circuit" menu, parameter 16 = circulation pump.

Access level HS (heating specialist)

Function

- 1 Function according to time program
- 2 While hot-water loading is active, the circulation pump is switched off

NOTEt:

During legionella protection, the circulation pump is continuously running.

7.2.11 Switch-off of district heating control

Operation "District Heating" menu, parameter 01: Setting range is extended to OFF, -10 ... +50.

Function Setting OFF means district heating is deactivated.
District heating valve permanently in STOP position when deactivated.
The switch-over of the heat generator is controlled from the "District Heating" menu, parameter 01.

7.2.12 Return interval flushing

If the return max. limit is active and the district heating valve is opened less than 5%, the district heating valve is opened to 10% every 10 minutes for heat demand, so as to obtain an adequately precise return temperature measurement. This assures that the limit sensor is adequately supplied in the return.

7.2.13 Heat meter for additional limitation according to the volume flow or thermal output

The requirement for this function is the heat meter, whose information (pulse per volume or pulse per thermal output) is called upon for this limit. Calibration of the thermal output and the volume flow with parameters 12 and 13 allows calculating the entities thermal output and volume flow. These values are displayed with the key. Setpoint limits for thermal output and volume flow are entered under parameters 14 and 15.

This limitation function operates as PI controller above the setpoint value, using the same parameters as the temperature control function.

The values are independent of the outside temperature. The heat flow is derived from a volume signal in the following way:

The pulses for the amount of heat flowing through are counted, e.g. 5 pulses within a minute. Through calibration via parameter 12, the actual thermal output in kW is calculated.

for input 60 pulses/min. = 1 Hz

$$\dot{Q} = \frac{Q}{t} = \frac{60\text{kWh}}{\text{min}} = 3600\text{kW}$$

7.2.14 Charging pump (CHP)

NOTE This function is only active if the charging pump function was assigned to one of the outputs "direct heating circuit pump", "variable output 1" or "variable output 2" in the "Hydraulics" menu.

Function A charging pump to supply remote parts of the heating system is active at every heating or hot-water demand to the heat generator. It can be connected, through variable settings, at one of the variable outputs or at the direct circuit pump output.

Bus system A charging pump connected to the central device under address 10 will run as soon as any demand is present on the data bus (including all heating and hot-water circuits within the control network).

A charging pump connected to an extension controller (address 20, 30 ... 50) runs only on demand from the heating circuit associated with the respective control device.

Charging pump extended running time To avoid a high-temperature safety switch-off of the heat generator, a charging pump is switched off according to the set time delay when a request to the heat generator is withdrawn.

See also 5.4.1 "Hydraulics" menu (HYDRAULIC), Pg. 81

7.2.15 Primary pump

NOTE Function only active if the PRIMARY PUMP function was assigned to one of the outputs variable output 1 or variable output 2 in the "Hydraulics" menu.

Function The primary pump is the functional equivalent of a loading pump. It is only active when heating demand to the heat generator is present. Hot-water requests are not considered.

Bus system A primary pump connected to the central device under address 10 will start up as soon as any request is present on the data bus (including all heating and hot-water circuits within the control network).

A primary pump connected to an extension controller (address 20, 30 ... 50) runs only upon a demand from the heating circuits associated with the respective control device.

Primary pump extended running time To avoid a high-temperature safety switch-off of the heat generator, the primary pump is switched off according to the set time delay when a request to the heat generator is withdrawn.

7.2.16 Boiler circuit pump

NOTE This function is only active if the BOILER CIRCUIT PUMP 1 function was assigned to one of the outputs, i.e. direct heating circuit pump, variable output 1 or variable output 2, in the "Hydraulics" menu.

Function This function is mainly used with multi-boiler systems with thermohydraulic distributors and is used for water-side cut-off of a heat generator not in use. The variable output controls a boiler circuit pump with a non-return valve with a faulty spring or a motorised shut-off device. The function becomes active immediately upon demand for the heat exchanger. The heat exchanger is not enabled until the set pre-running time expires. Once the heat generator switches off, the variable output remains active for the duration of the set extended running time.

Boiler circuit pump 2 For systems with two individual boilers or a double boiler, two boiler circuit pumps can be connected. The second output then controls the boiler circuit pump of the downstream boiler.

Boiler circuit pump pre-running time The pre-running time determines the switch-on delay of the burner and thus the pre-running time of the respective shut-off device used (motor valve, motor throttle) to ensure trouble-free circulation within the heat generator when switching on the burner.

The setting of a pre-running time is only relevant if a shut-off device (e.g. motor throttle) is used instead of a boiler circuit pump at a variable output. Actuators with reversible motors must be operated via an auxiliary relay with a switch-over contact (separate control phases L_{open}/L_{closed}).

Boiler circuit pump extended running time When the burner switches off, a boiler circuit pump is switched off after a delay based on the set time to prevent a safety switch-off of the heat generator at high temperatures.

The extended running time depends on the type of heat exchanger used and is to be adapted accordingly.

NOTE An external heat generator disable affects the output of the boiler circuit pump.

7.2.17 Return increase

Function To prevent the return flow temperature from dropping below the minimum return temperature required by some heat generators, the control system features various options for raising the return temperature. Once one of these return control options is active, a menu is activated where the appropriate settings can be entered. The parameter minimum return limit determines the lowest allowable return flow temperature for systems with direct or indirect return control. When the heat generator return temperature drops below the set limit, the respective return control device is activated and raises the return temperature until the set temperature is reached or exceeded. In Software Version 3.1 the return flow control is linked to the controller. This means that there is a fixed assignment between the heat generator and the return temperature mixing circuit. The output of the mixing valve pump is working according to the same function as the boiler charge pump; the same follow-up time is used. If the heat generator is switched off (no heat demand) the valve is controlled to the setpoint as long as the follow-up time has not expired – after that time the heat generator is disconnected from the waterflow and the mixing valve is completely opened.

See also 5.4.8 "Return increase" menu (RETURN CONTR), Pg. 105

7.2.17.1 Bypass pump (RBP)

Function The simplest way of controlling the return flow temperature is by means of a bypass pump. When the return temperature in the heat generator drops below the set boiler return minimum temperature limit, flow mixing is initiated by switching on a bypass pump parallel to the heat generator. As soon as the return temperature rises above the return minimum temperature plus the return switching differential, the bypass pump will be deactivated after the set delay time (extended pump running time "bypass pump"). As the mixing itself is not controlled, the bypass cross sections must be taken into account for the system layout.

When the switch-off condition is reached, the bypass pump is switched off with a time delay in accordance with the set value.

NOTE To avoid intermittent operation of the bypass pump, the return sensor must always be positioned downstream of the mixing point for this mode of return temperature control.

7.2.17.2 Return maintenance through controlled feed water addition

Function If the control unit is equipped with a mixed heating circuit output, this output can be programmed for controlled flow mixing.

In this mode of return control the programmed mixed heating circuit adjusts the return temperature to the return temperature setpoint. The adjustment is independent of the status of any start-up protection of the heat generator. The return sensor for this function is connected at the sensor input of the respective mixed heating circuit (e.g. flow sensor 1 for mixed heating circuit 1).

The mixed heating circuit pump operates like a boiler circuit pump without boiler start-up protection for this purpose.

7.2.17.3 Indirect return increase

Function Indirect return increase is realised by means of the mixed heating circuit valves in the heating circuits. It only works for systems without a bypass pump and without controlled flow mixing.

When this function is active, two values are calculated independently for regulating each mixed heating circuit. The first value is the control variable for the flow setpoint of the heating circuit; the second is the control variable for the return setpoint.

The control variable used for mixed heating circuit control (mixed heating circuit control variable) results from the superimposition of both values. In this the adjustment of the return temperature is treated with priority.

Indirect return control is only active with mixed heating circuits that are in heating operation as well. It does not affect a heating circuit in reduced operation.

To avoid excessive pulsing, we recommend enabling the connected consumers (heating and hot-water circuits) with staggered switch-on times.

This function does not affect direct heating circuits.

NOTE Indirect return control is only feasible for systems without bypass pumps and without controlled flow mixing.

7.3 Heating circuit

7.3.1 General heating circuit functions

7.3.1.1 Heating curve

The prerequisite for a constant room temperature is the exact setting of the heating curve of the relevant heating circuit as well as a correct design of the heating system on the part of the heating technician according to the heat demand calculation.

If adjustments are necessary, they should be made in small steps at a distance of a few hours to assure that a steady condition is obtained.

Differences that can be balanced by installing a wall device (see available accessories) may occur between the measured room temperature in the inhabited area and the desired room temperature.

7.3.1.2 Heating curve setting (heating curve)

Press and hold the input button for 3 seconds to access the "Heating Curve" menu.

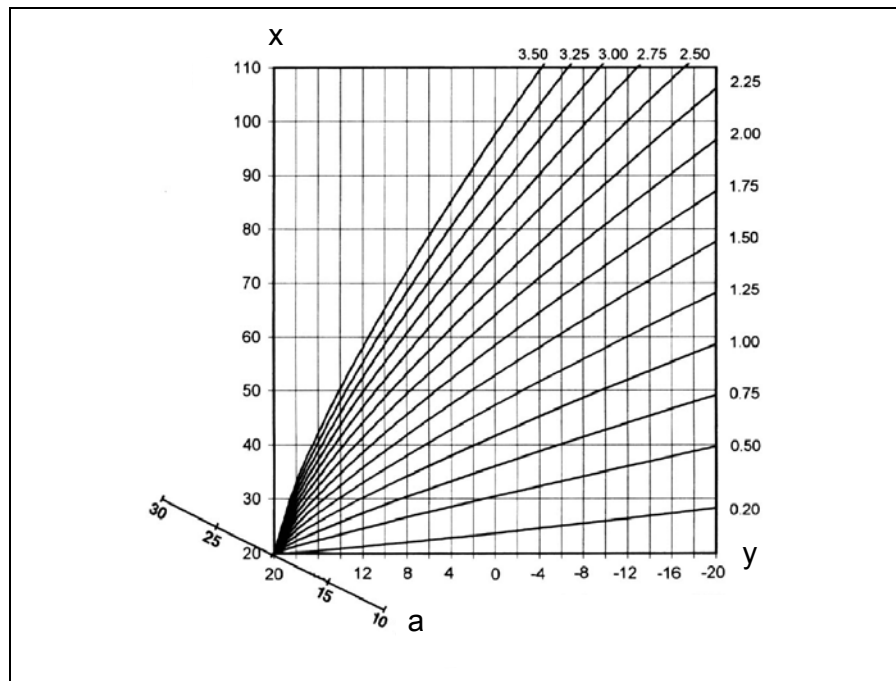

The slope of the heating curve describes the relation between the change in the flow temperature and the change in the outside temperature. With a larger heating surface, such as with floor heaters, the heating curve has a less extreme slope than with a smaller heating surface (e.g. radiators).

The set value refers to the lowest outside temperature used for heat demand calculation.

This parameter is to be set by the technician and should not be altered anymore.

The setting of the heating curve should be carried out only in small steps and at adequately long intervals so that a stable condition can be set. We recommended making any corrections in 0.1 – 0.2 steps after 1 – 2 days.

▲ ATTENTION

To measure the room temperature, the heating circuit of the most occupied room is to be used. Radiator thermostat valves are used together with correctly designed radiators to control the external heat gain and should hence be almost completely open. During the adjustment phase additional external heat sources like fireplaces, majolica stoves, etc. should not be used. Furthermore, during the measurement period excessive ventilation is to be avoided to prevent external cold from interfering with the adjustment process.

The measurement period covers basically the heating phases.

If the heating curve is correctly set, the room temperature remains constant according to the set daytime setpoint regardless of the changes in the outside temperature.

If an automatic correction of the heating curve (heating curve adaptation) is made at the service level, this parameter can no longer be manually set. Instead of the slope display the message HEATING CURVE starts to flash during the adjustment and is corrected continuously.

Recommended settings:

Floor heating: 0.3 ... 1.0

Radiator heating: 1.2 ... 2.0

Convectector heating: 1.5 ... 2.0

NOTE The heating curves are limited by the minimum and maximum temperature limits in their valid range. The relevant flow temperature is controlled within the limit range exclusively according to the specified limit values.

With the central device, the jump always occurs with the direct heating circuit (HC). In case of wall devices, the assigned heating circuit will be the first. If other heating circuits exist, their slope values can be selected with the relevant access authorisation and modified if necessary.

Setting 5.1.2.10 Heating curve, pg. 47

7.3.1.3 Reduced operation

See 5.2.5.1 Reduced operation, Pg. 79

7.3.1.4 Heating system

See 5.2.5.2 Heating system, Pg. 80

7.3.1.5 Heating circuit temperature limit

NOTE This function is not active if the heating circuit control is used as constant control (CC).

Function This function limits the flow temperature of a heating circuit. The minimum and maximum temperatures set in the relevant parameters of a heating circuit do not exceed or fall below the setpoints.

Minimum temperature limitation is not active:

- in case of switch-off in standby mode above the frost protection limit
- in case of switch-off in reduced automatic mode with the activated ECO function above the frost protection limit
- in case of switch-off in continuously reduced mode with activated ECO function
- in case of automatic summer switch-off

Application

- Floor minimum limit
- Ventilation pre-adjustment (warm air curtain)
- Convector heating

▲ ATTENTION

To protect the floor heating systems against accidental overheating (malfunction - manual mode) a controller-independent maximum temperature limit must be provided. For this purpose, we recommend a strap-on thermostat, the switching contact of which is looped through the control phase of the respective heating circuit pump. The thermostat is to be set to the maximum permissible system temperature.

See also 5.4.4 "Direct heating circuit" menu (UNMIXED CIRC), Pg. 92

7.3.1.6 Heating circuit temperature offset

Function For special applications this function offers the possibility to admit the heating curve of the direct heating circuit with a constant offset value. The demand value plus the offset value is transmitted to the heat generator.

The displacement of the heating curve is carried out in parallel with the flow temperature.

Application To ensure the desired setpoint temperature for remote heating circuits as well.

See also 5.4.4 "Direct heating circuit" menu (UNMIXED CIRC), Pg. 92

7.3.1.7 Heating circuit pump extended running time

Function The heating circuit pump ceases operation if there is no heat demand from the heating circuit. Safety switch-off of the heat generator is prevented.

While the pump extended running of a mixed heating circuit pump (MC-1 and MC-2 only) is active, the mixed heating circuit continues to adjust its setpoint without forwarding a demand value to the heat generator.

See also 5.4.4 "Direct heating circuit" menu (UNMIXED CIRC), Pg. 92

7.3.1.8 Screed function

NOTE This function is not active if the heating circuit control is used as constant control (CC).

The screed function is not available for the direct heating circuit.

Function The screed function is used exclusively for the required drying of newly applied screed on floor heating systems. The process is based on recommendations of the German Bundesverbandes Flächenheizungen (Federal Association for Surface Heating) concerning the heating of fresh floor covers (heating according to a mandatory temperature profile).

This is a special function that is not interrupted by any other control mode (including manual operation or emission measurement).

The screed function can be activated for mixed heating circuits and, in special cases (e.g. in conjunction with a condensing boiler) also for a direct heating circuit.

When the screed function is active, all weather-dependent control functions of the heating circuit concerned are switched off. The respective heating circuit operates independent of the control mode (switching times) as a constant temperature controller.

An active screed function can be deactivated at any time (parameter screed function = OFF).

On completion of the screed function, the heating circuit returns to operation according the current control mode setting.

The screed function consists of two steps:

Step 1 Function heating acc. to DIN 4725 Part 4 (setting 1)

- Constant heating at 25°C on the start day and for the following three days.
- Subsequently for another four days with the set maximum flow temperature with a maximum limit of 55°C.

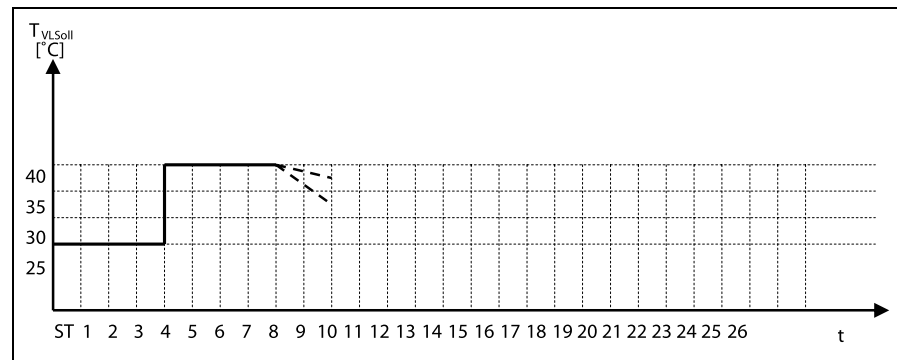

Maximum temperature setting = 40°C.

Progression of screed function over time with functional heating

Step 2 Heating function for floor covering (setting 2)

The heating of the floor covering follows a preset temperature profile.

Starting with 25°C on the first day, the requested temperature rises by 5°C per day over the following days until the maximum temperature of the heating circuit is reached. After that the setpoint temperature is reduced with the same stepping until the base point of 25°C is reached again.

Example Maximum temperature setting for the heating circuit = 40°C

1. day: constant heating at 25°C
2. day: constant heating at 30°C
3. day: constant heating at 35°C
4. day: constant heating at 40°C
- 5.-15. day: constant heating with max. flow temperature
16. day: reduced heating at 35°C
17. day: reduced heating at 30°C
18. day: reduced heating at 25°C

On the start day, heating to 25°C is carried out until midnight. The first day of floor covering heating starts at midnight of the following day.

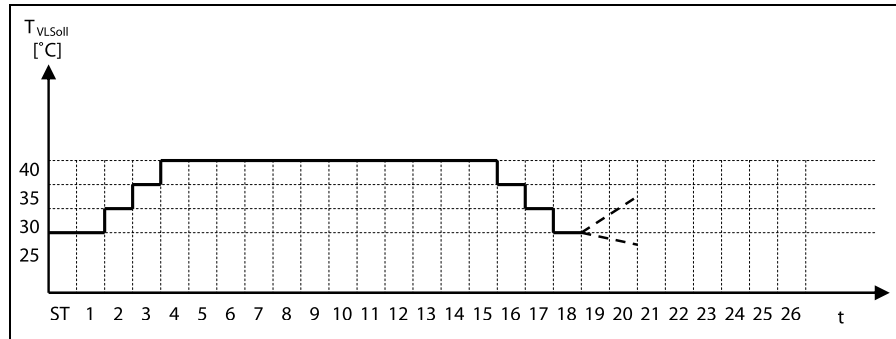

Maximum temperature setting = 40°C.

Progression of screed function over time with floor covering heating.

7.3.2 Heating circuit constant temperature control

NOTE This function must be activated in the "Hydraulics" menu for the corresponding heating circuit (direct heating circuit, mixed heating circuit 1, mixed heating circuit 2).

Function The control circuit is operated with a constant temperature specification. The demand value is transmitted to the heat generator. The switching program of the respective heating circuit and the control modes can be activated.

The specification of the constant temperature occurs via parameter "constant temperature setpoint".

For constant temperature controls (e.g. for baths), 2 different setpoints can be adjusted via heating circuit parameters:

- a day setpoint with parameter 11
- a night setpoint with parameter 48

The setpoints can only be changed in the parameter list, but not in the time program. In the time program the symbol --.- will be displayed instead of the setpoint.

Upon activation of the function on a mixed heating circuit output, a flow sensor is to be set for adjustment of the flow temperature.

See also 5.4.4 "Direct heating circuit" menu (UNMIXED CIRC), Pg. 92

7.3.3 Fixed-value control

Function As with constant control. The demand value is not transferred to the heat generator, and the switching time program and control modes can be activated.

7.3.4 Consideration of the room temperature/room influence

7.3.4.1 Heating circuit room connection

Function This function determines the enabling of the room sensor in conjunction with a wall device/room sensor with the direct heating circuit and all parameters affected by the room temperature sensing depending on the application.

No room sensor **with the following conditions:**

- No room sensor connection with installation of the room sensor outside the inhabited area (e.g. in unheated rooms like basements etc.).
- No room sensor connection with multi-family dwellings that work with different room temperatures based on different assignments and do not offer a reference room.
- With room connection switched off, the current room temperature is not displayed in the system information.
- The flow temperature is corrected purely by weather conditions.

Room sensor active **for room influence and connected outside sensor:**

- With the room sensor switched on, the heating circuit is controlled based on the weather taking into account the current room temperature. The room temperature deviation is taken into account based on the room factor parameter setting.
- If SDW 30 wall devices are connected, the actual room temperature is indicated in the basic display instead of the heat generator temperature.
- When the actual room temperature drops below the current setpoint room temperature + 1 K, any active summer switch-off is disabled, provided automatic operation was not selected.

Room sensor active, operation disabled This setting enables the room temperature-related functions, while operation via the wall device is disabled.

Application Public buildings (government, schools, public facilities, etc.) where only the registration of the room temperature is required.

Room sensor off, operation active At this setting the room sensor is only used as a display device without influencing the room temperature-related functions. The operation of the wall device is possible without restrictions.

Application All system layouts that exclude room influence while the display of the actual room temperature is still required (in contrast to setting OFF).

See also 5.4.4 "Direct heating circuit" menu (UNMIXED CIRC), Pg. 92

7.3.4.2 Heating circuit room factor

Function This function determines to what extent a deviation of the room temperature from the setpoint affects the control of boiler flow temperature.

If there is no difference between the desired (TARGET) and the current (ACTUAL) room temperature, the direct heating circuit's flow temperature is controlled according to the set heating curve.

If there is a difference between the room temperature and the setpoint, the heating curve is shifted parallel to the room temperature axis so that the deviation is compensated. The amount of the displacement depends on the setting of the room factor.

The following relation applies:

$$\text{Corrected room setpoint } t = \text{Set room setpoint } t - \left(\frac{\text{Deviation} \times \text{Room factor}}{100} \right)$$

Example:

set room setpoint = 21°C

actual room temperature = 20°C

Deviation = -1 K

For a room influence of 100%:

$$\text{Corrected room setpoint } t = 21^\circ\text{C} - \left(\frac{-1 \text{ K} \times 100}{100} \right) = 22^\circ\text{C}$$

The boiler temperature is controlled according to a heating curve which corresponds to a room temperature setpoint of 22°C.

High settings lead to a quicker adjustment of the control deviation, while they reduce the stability of the control circuit and can lead with excessively high setpoints to the oscillating of the control variable (room temperature).

7.3.4.3 Heating circuit room controller

With this setting the heating circuit concerned can be controlled through a room controller. This requires a wall device SDW 30 with room control function. The room controller directly determines the required flow setpoint and transmits this information to the central device.

With this setting the control of the respective heating circuit is completely room-guided. Weather condition control is inactive. However, the parameters for weather response ("heating curve" setting) can still be entered.

7.3.4.4 Switch-on/switch-off optimisation

Function The switch-on optimisation leads to the set day setpoint being reached at the beginning of the set time period of the heating cycle, e.g. 6 a.m. to 10 p.m., at 6 a.m. Without switch-on optimisation, the heat generator would not be started until 6 a.m. The desired day setpoint is not reached until some time later.

Switch-on time optimisation can occur either with or without a room sensor.

Parameter settings for the switch-on optimisation in the HC, MC-1 and MC-2 menu

Parameter	Designation	Setting range/Setting values		Factory setting
3	Room connection (in conjunction with room sensor)	OFF	Display of heat generator temperature, room sensor off, operation active	OFF
		1	Display of room temperature, room sensor active, operation active	

Parameter	Designation	Setting range/Setting values	Factory setting
		2 Display of room temperature, room sensor active, operation disabled	
		3 Display of room temperature, room sensor off, operation active	
4	Room factor	OFF	OFF
		10 ... 500% Influence active	
		RC Room controller active	
26	Room setpoint ramp	OFF, 0.5 ... 60 K/h	OFF
41	Switch-on optimisation	OFF	OFF
		1 Adaptation off	
		2 Adaptation on	
		3 Adaptation restart	
42	Min. pre-heat time	0 ... set value of parameter 43	0,5
43	Max. pre-heat time	Set value of parameter 42 to 30 h	5
44	Min. jump back temperature	0 ... 30°C	5
45	Without room sensor	0 ... 10°C	1
46	Pre-heat time at 0°C	0 ... 30 h	1
47	Lowering ramp	0 ... 500 %	100

Activation of switch-on optimisation

- ▶ Set Parameter 26 room setpoint ramp to OFF.
- ▶ Set parameter 41 switch-on optimisation to 1 = adaptation off or with connected room sensor to 2 = adaptation on.

NOTE If parameter 41 switch-on optimisation is set to 1, parameters 42 min. pre-heating time and 43 max. pre-heating time are not required.

If parameter 41 switch-on optimisation is set to 2, parameters 45 no room sensor and 46 pre-heating time at 0°C are not required.

Parameter information**Parameter 41 switch-on optimisation, 03 adaptation restart**

If a controller is exchanged or structural changes are made, e.g. improvement in insulation, replacement of windows etc., adaptation must be restarted.

Parameter 42 min. pre-heating time

A pre-heating time takes place before the set heating cycle, e.g. 6 a.m. This is only possible with a room sensor. Without a room sensor, parameter 45 is active without a room sensor.

Parameter 43 max. pre-heating time

This parameter setting limits the duration of pre-heating, which is set to 5 hours at the factory. This is only possible with a room sensor. Without a room sensor, parameter 45 is active without a room sensor.

Parameter 44 min. jump back temperature

This parameter setting specifies the outside temperature up to which the adaptation works. If this parameter is set to 5°C, for example, adaptation is active up to 5°C and deactivated starting with an outside temperature of 6°C.

Parameter 45 without room sensor

The set room temperature is increased by a specific amount, e.g. 1°C, during switch-on optimisation so that the heat generator gets a higher temperature setpoint and thus the heating circuit can heat up faster.

Parameter 46 pre-heating time at 0°C

By setting the quick heat-up time at an outside temperature of 0°C, the heat-up speed affected. This value is included in the calculation of the pre-heating time.

Pre-heating time = pre-heating time 0°C/20°C x (room setpoint – outside temperature)

Parameter 47 lowering ramp

This parameter setting specifies how fast the temperature is reduced before the end point of the heating cycle is reached, e.g. 10 p.m.

Switch-on optimisation with room sensor (adaptation)

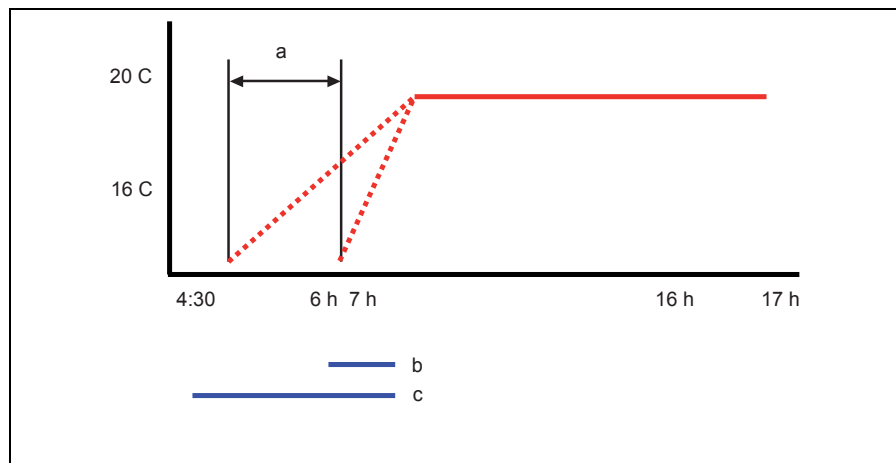

a Calculation via the controller

b min. pre-heat time

c max. pre-heat time

Switch-on optimisation without room sensor

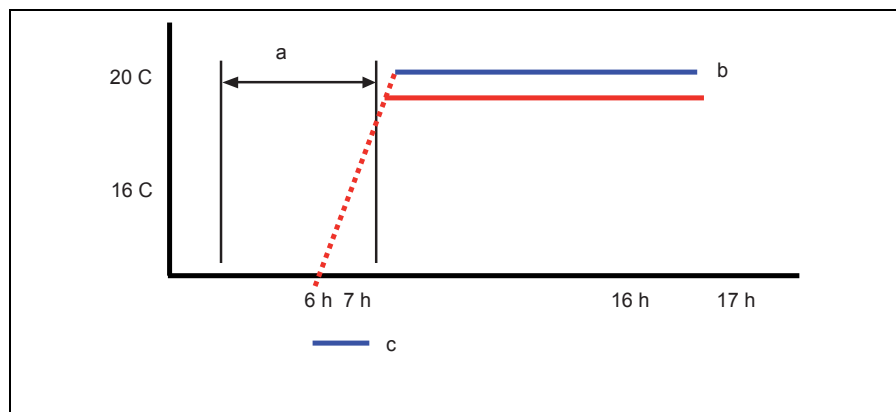

- a Calculation by the controller based on the outside temperature
- b 21°C parameter 45 without room sensor
- c Pre-heat time at 0°C

7.3.4.5 Room setpoint ramp

Setting range OFF, 0.5 ... 60 K/h

Function This function is only active in conjunction with an "RC" (room controller) function. The set value acts as a filter between the setpoint jump (change of the room setpoint temperature setting) and the room setpoint at the controller output. The ramp functions as an artificial down time on the control path and slows heating/cooling. Configuration of the actual control path is dependent on this.

Application In historic buildings (churches, galleries), it is important that heating up and cooling down are damped via a room setpoint value ramp so that masonry and artwork are not damaged.

The function starts with the switching times switch-on/switch-off point and the control mode change.

NOTE This function helps prevent jumps in temperature. For this reason:

- The ramp is recalculated starting from the actual room temperature after a power failure. A setpoint jump does not occur.
- If a new setpoint jump (setpoint increased, lowering initiated) occurs before the room setpoint temperature is reached, the new ramp is recalculated starting with the current actual room temperature.
- An activated ramp takes affect in all control modes.

7.3.4.6 Heating limit function

This parameter supplements the summer switch-off function. It deactivates the respective heating circuit as soon as the computed flow temperature setpoint approaches the current room temperature setpoint.

The heating limit parameter can be activated separately for each heating circuit.

Function Switch-off: Flow setpoint < (current room setpoint + heating limit setting)

Switch-on: Flow setpoint < (current room setpoint + heating limit setting + 2 K)

Example:

Room setpoint = 22°C, heating limit setting = 2 K

Switch-off at flow setpoint 24°C (22°C + 2 K)

Switch-on at flow setpoint 26°C (22°C + 2 K + 2 K)

Boundary conditions

The SUMMER SWITCH-OFF function ("System Parameters" menu, parameter 04) has priority over the HEATING LIMIT function.

The FROST PROTECTION function ("System Parameters" menu, parameter 05) has priority over the HEATING LIMIT function.

7.3.4.7 Heating circuit room frost protection limit

Function This function determines the room temperature of the corresponding heating circuit during switch-off mode with frost protection active

- during holiday mode
- in automatic mode between the heating cycles with active ECO function (see parameter 1 - Reduced mode).
- in constant reduced mode with active ECO function (see parameter 1 - Reduced mode)

In conjunction with a wall device, the heating circuit is adjusted to the frost protection room temperature.

Without a wall device, the set value serves as a specification for the lowered room temperature and is adjusted to it.

NOTE With continuous frost protection mode and sensitive objects in the house like antiques, plants, etc. the set value is to be adjusted accordingly.

7.3.4.8 Mixed heating circuits cooling switch-over

Function If the cooling function was activated at a variable output ("Hydraulics" menu, parameters 6 and 7, setting 25), the additional parameters appear in the "System Parameters" menu, parameter 25 and in the "Mixed Heating Circuit 1"/"Mixed Heating Circuit 2", parameter 28.

The cooling function must also be activated via parameter 28 "heating circuit cooling setpoint temperature" in the "Mixed Heating Circuit 1"/"Mixed Heating Circuit 2" menu for each heating circuit.

The cooling function for the corresponding heating circuit is active; if a setpoint temperature was configured (<> OFF), the cooling function is active for the corresponding heating circuit.

The output for the cooling function works without pump forced operation.

Wall device functionality limitation:

If a wall device is connected to a heating circuit, all factors that influence a room remain ignored during active cooling (correction

of room setpoint, thermostat function, room controller setpoint etc.).

Switch-over from heating mode to cooling mode:

If the outside temperature is greater than summer switch-off (see "System Parameters", summer parameter) and the switch-on temperature for cooling, the cooling function is active.

If the outside temperature is lower than the summer switch-off and the cooling switch-on temperature of cooling -1 K, the cooling function is not active. A switching differential is required.

With the cooling function active, the "cooling switch-over" output in the "Hydraulics" menu, parameter 06/07, setting 25 = ON. This is switched on inversely via an input on the heat pump. If cooling mode is interrupted due to the switching conditions of the timer (ECO lowering phase), the output switches OFF, even if the switching conditions are present otherwise.

Heating circuit correction:

For cooling operation, the mixed heating circuit corrects to the setpoint temperature at the flow sensor (see the "Heating Circuit" menu, heating circuit cooling setpoint temperature parameter) and functions as a heating controller.

Humidistatic switch-off:

To prevent excessive humidity build-up in the room, a humidistat can be connected to a variable input.

Cooling without humidistatic switch-off:

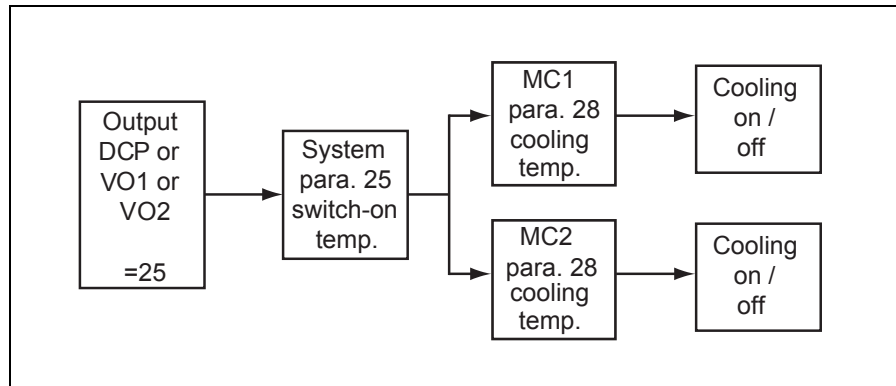

Cooling with humidistatic switch-off:

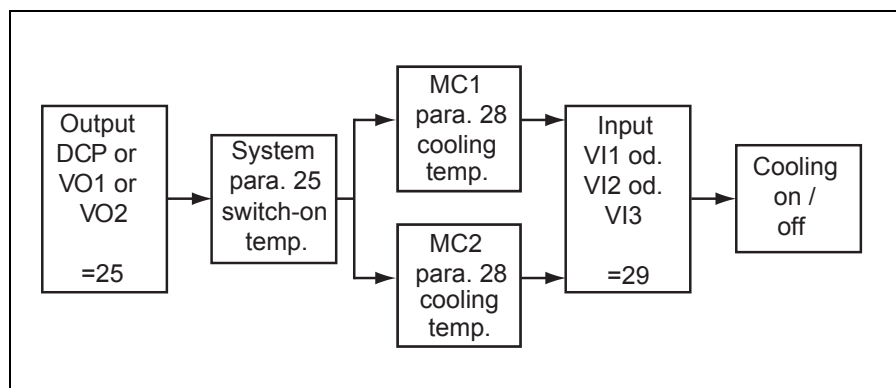

NOTE If the set humidity is exceeded, a short-circuit results. A triggered humidistat interrupts cooling mode.

Active cooling does not affect the heat generator. Demand from other heating circuits for the heating generator or hot-water loading is served in parallel.

- ▶ Ensure that the cooling circuits to be cooled are decoupled hydraulically from the actual heating system during active cooling.
- Configured cooling is only active in automatic mode
- When setting ECO mode, cooling does not take place during a lowering phase
- With the lowering mode setting, cooling is carried out at the same cooling temperature (continuous cooling)
- Cooling mode is not active in any other control modes (HEATING, RED. HEATING, STANDBY, PARTY TIL, ABSENT TIL, HOLIDAY TIL)

7.3.4.9 Heating circuit name

Access code No access restriction

Factory setting empty

Setting range 00000 ... ZZZZZ

Function The max. three heating circuits available in a controller are provided with the short names DC (direct heating circuit), MC1 (mixed heating circuit 1) and MC2 (mixed heating circuit 2). The heating circuits are given unique names here.

To enable easy assignment of the heating circuits to the living area by the end customer, a unique 5-digit short name can be assigned to each of the three heating circuits.

With the "empty" setting, a unique name is not assigned. The default short name appears.

- ▶ Set the flashing position with the input button.
- ▶ Confirm by pressing the input button .
- ▶ The remaining positions are set in the same way.

The display of the unique heating circuit name appears

- in the menu selection
- in the parameter tree
- on the information level

7.3.4.10 Room thermostat function (maximum room temperature limit)

Function This function determines a room temperature-related limit with adjustable switching differential. If the room temperature of the relevant heating circuit exceeds the current daytime or reduced room setpoint by the set switching differential, heating is temporarily stopped (heating circuit pump switched off).

Heating is resumed as soon as the room temperature of the respective heating circuit drops 0.5 K below the switch-off temperature.

Example:

Daytime room setpoint = 22°C

Thermostat function set value = 4 K

Interruption of heating:

$$T_{\text{Room}} > (22^{\circ}\text{C} + 4 \text{ K}) > 26.0^{\circ}\text{C}$$

Resumption of heating:

$$T_{\text{Room}} > (26^{\circ}\text{C} - 0.5 \text{ K}) < 25.5^{\circ}\text{C}$$

Set value OFF disables the thermostat function.

NOTE The thermostat function is effective while heating and in reduced mode.

The thermostat function is disabled when outside temperature frost protection is active.

See also 5.4.4 "Direct heating circuit" menu (UNMIXED CIRC), Pg. 92

Special mixing circuit functions (district heating control devices only)

Return limit By setting an additional return sensor in the mixed heating circuit, the return temperature can be limited using this function. This is a maximum temperature limit.

With some applications, an excessively high return temperature causes problems (e.g. district heating or condensing applications). They can occur if heat is not being extracted in the occupied room (e.g. thermostat valve closed).

If the return temperature exceeds the set maximum value, the mixed heating circuit valve is adjusted to this maximum temperature. The flow temperature then remains ignored.

7.3.4.10.1 Mixed heating circuit control

7.3.4.10.1.1 Proportional part Xp

The proportional band Xp defines how a step change of the setpoint effects a change of the corresponding actuator according to the selected setting.

Example:

Consider an actuator moving through an angle of 90° in an action time of two minutes. When a sudden flow temperature control deviation of 10 K occurs (e.g. when the system switches from reduced to daytime operation) and the P-part setting is 5%/K, the actuator has to open by 50% (5%/K x 10 K). Consequently, the duration of the actuation pulse is one minute (= 50% of the actuator runtime).

7.3.4.10.1.2 Integral action time T_n

The integral part (adjustment time) determines the dynamic behaviour of the controller and thus the time required by the controller to adjust for the actual control deviation. The adjustment time is independent of the amount of deviation.

Example:

With a sudden flow temperature control deviation of 10 K (e.g. when the system switches from reduced to daytime operation) and an I-part setting of 7 minutes, the controller will adjust for the new (10 K higher) flow temperature after the set time.

NOTE The adjustment time can be determined through the Ziegler-Nichols method. The mixed heating circuit is closed, initially, and the heat generator is taken to the maximum temperature for the heating circuit concerned. As soon as half of all consumers at the circuit to be measured have been opened, the mixer is fully opened from cold condition (room temperature) by means of the relay test function. The heat-up curve, i.e. the temperature progression over time following this action, shows an inflection point. The crossing of the tangent through that point and the time axis is the delay time. This value multiplied by the factor 3.3 is the optimum integral action time for this heating circuit.

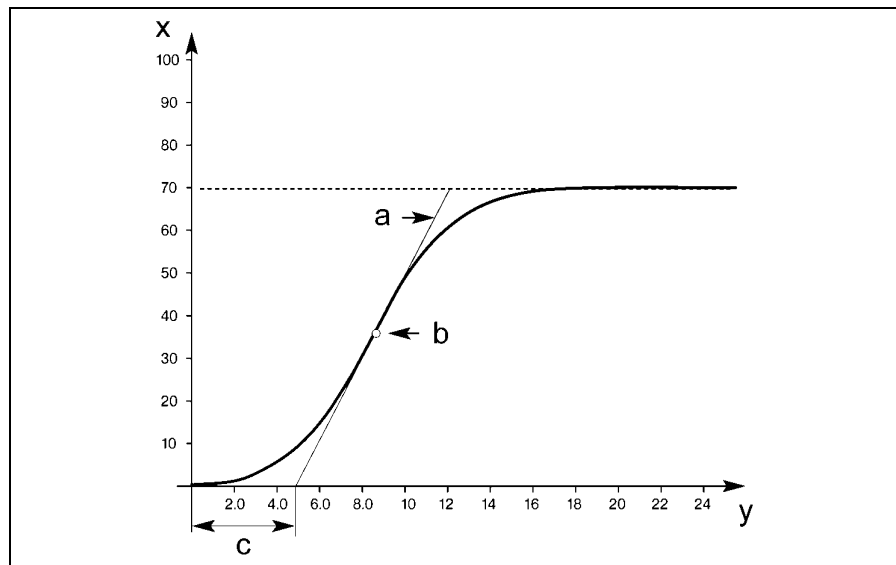

Application	Adjustment time
Floor heating and other static heating surfaces	10 - 30 min.
Radiator heating	6 -10 min.
Convactor heating	3 - 6 min.

7.3.4.10.1.3 Sample time T_a

The sample time is a controller-internal value which defines the time interval between two subsequent actuator pulses in the presence of a control deviation. Shorter sample times allow finer adjustments.

7.3.4.10.1.4 Actuator runtime

This function allows adjustment of the actuator, with regard to its finite runtime, to the control characteristics, meaning that actuators with different runtimes (e.g. 1 min., 2 min., 4 min.) react to the same deviation by readjusting by the same amount through adapting the action times. The integral action time T_n remains unchanged here. However, care must be taken that the latter must always exceed the runtime of the respective actuator. If necessary, actuators must be used with other runtimes.

Example

Coaction of P-part, I-part, adjustment time and sample time

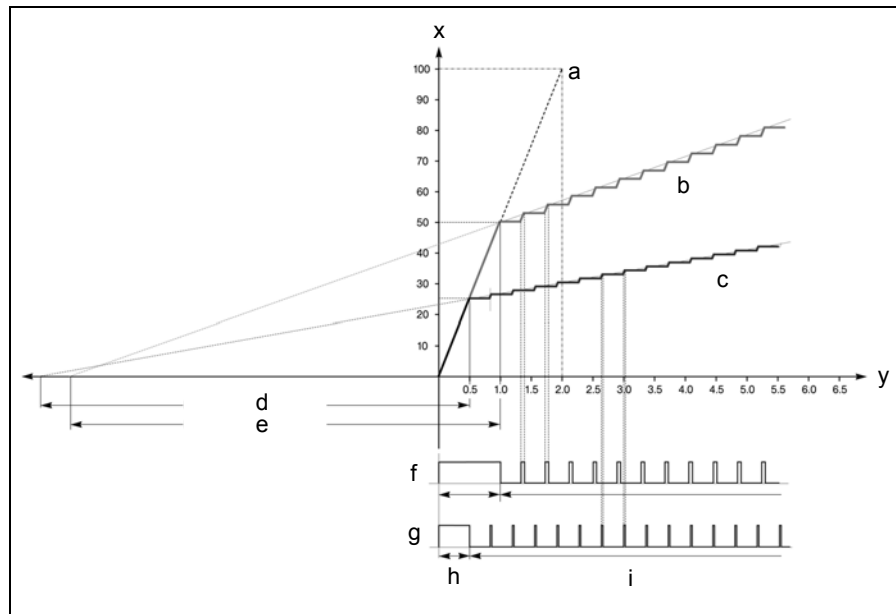

- | | | | |
|---|---|---|--|
| a | OPEN position | g | Actuator pulse with control deviation $X_W = 25\%$ |
| b | Actuator behaviour with control deviation 50% adjustment time $T_n = 7$ min. | h | P-part |
| c | Actuator behaviour with control deviation 25 % adjustment time $T_n = 7$ min. | i | I-part |
| d | Adjustment time T_n ($X_W = 25\%$) | x | Mixed heating circuit opening (%) |
| e | Adjustment time T_n ($X_W = 50\%$) | y | Action time (min.) |
| f | Actuator pulse with control deviation $X_W = 50\%$ | | |

**Jump response to various control deviations
(open control circuit, actuator removed)**

Adjustment time $T_n = 7$ min.

Sample time $T_n = 20$ sec.

Mixed heating circuit runtime = 2 min.

The P-pulse that brings the mixed heating circuit to the new position and is proportional to the control deviation is followed by additional actuation pulses if the control deviation is not yet remedied (I-part). The adjustment time remains constant despite varying control deviations.

7.3.4.10.1.5 Actuator end position function

This function determines the type of control signal in the end positions OPEN or CLOSED of each actuator.

1 = Continuous voltage at connection OPEN or CLOSED at the respective end position

2 = De-energised at end position OPEN or CLOSED respectively

Recommendation for the basic setting of the adjustment time with different heating systems:

7.3.5 Hot-water production

7.3.5.1 Hot-water tank loading (SLP)

Function The output controls a hot-water circuit loading pump during the respective operational-readiness times upon demand.

Hot-water circuit - daytime The hot-water daytime temperature provides for the desired hot water temperature during hot-water circuit operational-readiness times in automatic mode and in the PARTY and HEATING control modes.

This set value is the initial value for the temperature specifications that can be set for each heating cycle in the switching-time programs. The temperature settings in the switching time programs are automatically adjusted when the hot-water daytime temperature is changed.

Example: Before

Daytime hot-water temperature value: 50°C

Temperatures in switching-time program:

05:00 hours –	08:00 hours	60°C
08:00 hours –	16:00 hours	50°C
16:00 hours –	22:00 hours	60°C

Example: After

Daytime hot-water temperature value: 52 °C

Temperatures in switching-time program:

05:00 hours –	08:00 hours	62°C
08:00 hours –	16:00 hours	52°C
16:00 hours –	22:00 hours	62°C

Changed settings are stored when key or is briefly pressed again or after automatic return at a preset time. Once the settings are stored, the unit automatically switches to the basic display.

See also 5.1.2.4 "Daytime hot-water temperature" button, pg. 25

<i>Hot-water circuit - night-time</i>	<p>Hot-water economy temperature is the setpoint for the hot-water tank between the active operating mode times in automatic mode.</p> <p>If a hot-water thermostat is used to determine the water heater temperature, the parameter for the setting of the economy temperature is skipped.</p>
<i>Legionella protection</i>	<p>In order to kill Legionella germs in the tank, a Legionella protection function can be activated. Activation is carried out in the "Hot Water" menu, parameter 2.</p> <p>To ensure full destruction of germs, the set value of the Legionella protection temperature must be at least 65°C.</p> <p>The setting is carried out with two parameters. The weekday for Legionella protection can be selected by the user with a freely accessible parameter. With parameters 03 and 04, the time and temperature can be set by the heating technician.</p> <p>NOTE The thermostat which controls the max. limit of the heat generator must be set to a higher setpoint than the setpoint of the legionella temperature.</p> <p>While the legionella protection is enabled, a relay output (variable output) can be complemented. For this, parameter 5, 6 or 7 in the "Hydraulic" menu must be set to 50. With this setting, e.g. external limiting facilities can be bypassed temporarily.</p>
<i>Temperature measurement</i>	<p>Type of temperature measurement</p> <p>This function determines the type of temperature measurement in the hot-water tank.</p> <p>In general, an electronic temperature sensor (immersion sensor in hot-water tank) is used. The temperature is measured via the change in resistance of this sensor here.</p> <p>Alternatively, hot water provision can also be controlled by a mechanical temperature controller (thermostat switching contact). A hot-water thermostat is connected to tank sensor input and set to the required setpoint hot-water temperature. When the thermostat requires energy via the tank sensor input (contact closed), the tank is loaded with hot water at the set hot water maximum temperature until the contact opens again.</p> <p>NOTE With hot water control through a thermostat, the current hot water temperature cannot be measured and registered and will</p>

therefore not be displayed as part of the system information. Also, the hot water nominal temperatures cannot be set.

Maximum hot water temperature This function limits the temperature in the water heater upward based on the set value. The desired water heater daytime temperature to be set on the user level is limited by this set value.

▲ ATTENTION

Hot water maximum temperature limit is a function protecting the tank and terminates hot water loading. If overshooting occurs, the tank loading pump switches off immediately. In this case it cannot be ensured that the set extended running time is adhered to.

NOTE If a hot-water circuit thermostat is used instead of an electronic sensor, the hot water maximum temperature setting (plus the specified temperature shift during loading) is forwarded to the heat generator.

Control mode With this function it is set how the rest of the heating system reacts to heat demand from the hot-water tank. There are 5 different setting options.

Parallel operation

During hot-water circuit loading, the heating circuits remain operative.

Priority mode

During hot-water loading, the heating circuits are put out of operation. They are restarted as soon as the hot-water circuit loading pump extended running time is over.

If the hot-water setpoint temperature is not reached after 4 hours, a fault message is indicated on the display.

Conditional priority

If the temperature of the heat generator has exceeded the loading temperature for the hot-water tank, mixed heating circuits are enabled. Non-mixed heating circuits (DHCP) remain disabled during hot-water circuit loading. The heating circuits are enabled according to the following criteria:

Enabling the heating circuits:

Heat generator actual temperature > hot-water setpoint temperature + hot-water switching differential/2 + 10 K

Disabling the heating circuits:

Heat generator actual temperature < hot-water setpoint temperature + hot-water switching differential/2 + 5 K

NOTE In this control mode, the loading temperature offset for the tank is to be selected so that the heat generator does not switch off before the heating circuits are enabled. A parallel shift of at least 10 K should be set so that this function can operate correctly.

Parallel operation based on weather conditions

Above the set outside frost protection limit, hot water provision is carried out in priority mode; in case of active frost protection there is a switch-over to parallel mode.

Priority mode with intermediate heating

With this setting hot-water circuit loading is limited to a maximum of 20 minutes in order to provide for a 10-minute long intermediate heating. The loading procedure is continued at the end of the intermediate heating. Hot-water loading and intermediate heating are carried out in an alternating order until hot-water tank loading is finished.

Priority isolating circuit

Hot-water loading is carried by means of a three-way switch-over valve; the heating circuit pump is also the hot-water circuit loading pump. At the end of the hot-water loading and at the expiration of the extended time the three-way switch-over valve is changed back to heating mode.

The heating circuit pump is connected at output direct heating circuit pump and the three-way valve to output tank loading pump in this case.

NOTE If there is no hot-water demand (standby), the valve is switched to the hot-water tank (relay output closed).

External mode (request does not act on heating generator and heating circuit)

In external mode, hot-water loading is switched only according to the set switching differentials. There is no heat demand for the

heat generator. There is no tank priority mode for the heating circuits. The parameters boiler parallel shift, tank discharge protection, pump extended running time and boiler start-up protection no longer act on the hot-water loading pump.

Tank discharge protection

With discharge protection activated and a hot-water demand present, the hot-water loading pump enabled only when the temperature in the heat generator rises by more than 5 K above the current temperature in the hot-water tank.

This measure prevents any rear tank discharge through the heat generator. The hot-water loading pump is disabled again as soon as the temperature differential between the heat generator and the hot-water tank has dropped to less than 2 K.

NOTE The heat generator minimum temperature limit operates continuously to protect the heat generator and blocks the hot-water loading pump in case of temperatures below the set value.

▲ ATTENTION

In case of hot-water temperature specifications above 60°C, this function should not be activated to avoid safety switch-off (in particular for heat generators with a low water capacity).

Tank discharge protection must be set accordingly for hot-water loading from buffer tanks.

Boiler temperature offset This function determines the default setting of the tank loading temperature compared to the set hot-water circuit setpoint. In case of setpoint modifications the heating energy needed for the hot-water supply is adjusted.

In case of several devices in the bus system and several hot-water circuits the tank loading temperature depends on the highest setpoint if several tanks are loaded simultaneously.

Switching differential This function determines the size of the hot-water circuit switching differential. The switching differential affects the relevant hot-water setpoint symmetrically.

Loading enabling The current hot-water temperature is lower than the hot-water setpoint by half the amount of the hot-water switching differential

Pump extended running loading cancellation The current hot-water temperature overshoots the hot-water circuit setpoint by half the amount of the hot-water switching differential. After switching-off the heat generator, the tank loading pump is stopped only after a time delay to prevent a safety switch-off in case of high temperatures. The set value can be adjusted to the holding capacity of the hot-water tank used.

NOTE Excessively long extended running times unnecessarily interrupt heating and increase the temperature in the hot-water tank.

Depending on the parameter setting, a setpoint present in the system may or may not be forwarded to the heat generator during the extended running time

The boiler is operated according to the following rules during a tank pump extended running time:

–	Parallel hot-water peration	Hot-water priority mode	Conditional hot-water priority mode	
–	HC setpoint	HC setpoint	DC setpoint	MC setpoint
AUTO	Active	OFF	OFF	Active
OFF	OFF	OFF	OFF	OFF

Tank sensor 2 For complete loading of a hot-water tank by means of automatic measuring point switch-over between tank sensors 1 and 2 (layer loading). The measured value of the hotter sensor (SF1 or SF2) is evaluated for the activation of the loading pump. Termination of loading is carried out on the basis of the measured value of the colder sensor. The set values for the hot-water setpoint temperature and the specified hot-water switching differential continue to apply.

See also 5.2.4 "DHW" menu, pg. 77

Quick hot-water connection in cascaded systems

With cascaded systems, it is often the case that all heat generators are often not needed for hot-water production. In addition, the required heat generators must be connected faster than when heating.

Function If there is a demand for hot water, a fixed value of 10 seconds is used for connection of the subsequent stages up to the set

maximum stage number for quick hot-water connection instead of the general connection delay ("Cascading" menu, parameter 02).

For further stages, connection occurs based on the connection delay that can be set.

For hot-water loading without heating (tank priority), the number of heat generators is limited by the setting in the quick hot-water connection parameter.

With parallel operation (heating circuit and hot-water demand simultaneously), there is no stage number limitation.

With active hot-water loading, reversion of stages occurs under consideration of the configured switch-off delay.

If heating circuit operation is active with more stages than were enabled for hot-water circuit operation and hot-water loading then occurs in priority mode, the stages above and beyond the number of stages enabled for hot-water loading are switched off directly. Reversion of the activated stages does not occur in parallel operation.

The "stage sequence switch-over power" must be taken into account for connection of the following stage.

Example:

- Cascaded system with five stages
- Parameter 02 = 1 min.
- Parameter 03 = 2 min.
- Parameter 09 = 3 min.

Heating

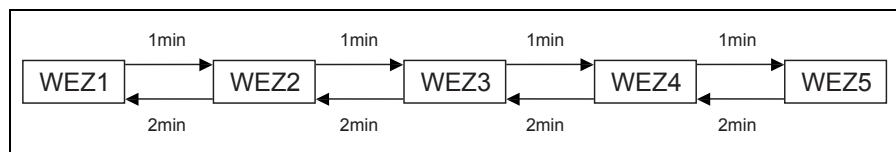

- Connection and disconnection with the configured delay of parameters 02 and 03.

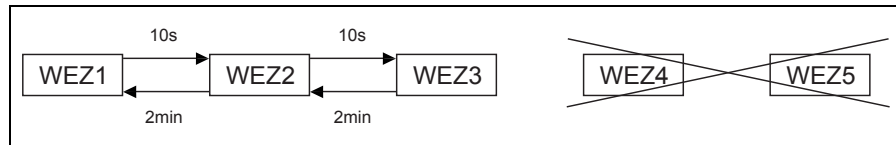
Tank priority (no heating demand):

- Connection immediately with minimum delay
- Reversion with configured delay P3

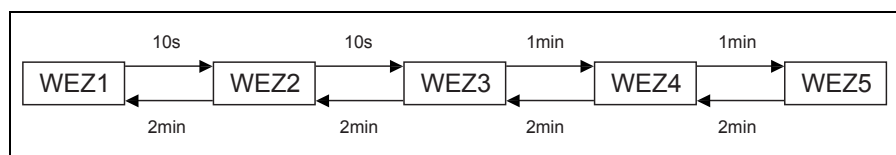
Tank parallel operation (combined operation: hot-water loading/heating)

- Connection up to the stage of parameter 09 with minimum delay for hot-water loading
- In case of further need via heating, further connection with configured delay of parameter 02
- Reversion with configured delay parameter 03

7.3.5.2 Circulation pump (CIR.)

NOTE This function is only available, if a variable output is assigned to a circulation pump

Function The output controls a hot-water circulation pump.

Economy interval (pulse) The use of the economy interval minimises the usual circulation losses owing to adjustable switch-on intervals during operation and determines the standstill time of the hot-water circulation pump within an adjustable period (economy interval).

Economy interval (period duration) This parameter determines the length of the period and hence the duration of the pause in a circulation pump pulse operating mode.

$$\text{Economy interval}_{\text{Pause}} = \text{Economy interval}_{\text{Period duration}} - \text{Economy interval}_{\text{Pulse}}$$

The switching-on degree is calculated from the ratio:

$$n = \text{Pulse time} / \text{Period duration} \times 100 (\%)$$

Example:

With an standstill time of 15 min. and a period of 20 min., the circulation pump will run for 5 min. before the subsequent pause of 15 min.

The following is used to calculate the switching-on degree:

$$n = 5/20 = 25\%$$

Switching times In this function a hot-water circulation pump can be coupled to an existing automatic program of a control circuit with regard to the switch-on and switch-off times. The hot-water circulation pump is in operation during the heating or hot-water cycles of the selected circuit and program.

NOTE If operation of the time programs P2 and P3 were not enabled (see "System Parameters" menu, time program parameter) and the circulation pump is assigned to one of these programs, the pump will operate according to the stored default times. The same applies if a switching-time program was selected that does not exist for the controller type in use (e.g. an MC2 for SDC 9-21).

Circulation pump with district heating Hot-water parameter 16 allows switching off of the circulation pump during hot-water loading.

7.3.5.2.1 Electrical heating element (ELH)

Function The electrical heating element (ELH) provides 2 different functions depending on the parameter settings.

1. Adjustment: in „Hydraulic“ menu, parameter 5,6 or 7, setting 5 = electrical heating element

The ELH controls (via circuit breaker) an electrical heating element in the water heater as long as the automatic summer switch-off is active. Switch-off of the electrical heating element occurs via an additional hot-water circuit thermostat to be created with the corresponding safety equipment.

This application is useful, if for example heating is completely turned off during summer operation and the process water should be heated with the means of the ELH.

2. Adjustment: in „Hydraulic“ menu, parameter 5,6 or 7, variable output = 47 Electrical water heater, and in „Hot Water“ menu, parameter 28 = switch-on delay electrical water heater and Parameter 29 = Offset Electrical water heater.

The electrical heating element will be enabled if the temperature value has dropped below the electrical water heater offset (EWB-Offset) of the hot water setpoint (Parameter 29, "Hot Water" Menu) and the switch-on delay (Parameter 28, "Hot Water" Menu) has elapsed afterwards.

This function allows setting the hotwater setpoint WS to a temperature value that has dropped below the EWB-Offset of the hot water setpoint. As soon as the hot water setpoint is reached, the function will be disabled again. The heat generator demand is switched off while EWB is active.

This application is useful for switching on the ELH in addition in case an electrical water heater has turned out or the capacity of the heat generator for the hot-water loading is not sufficient.

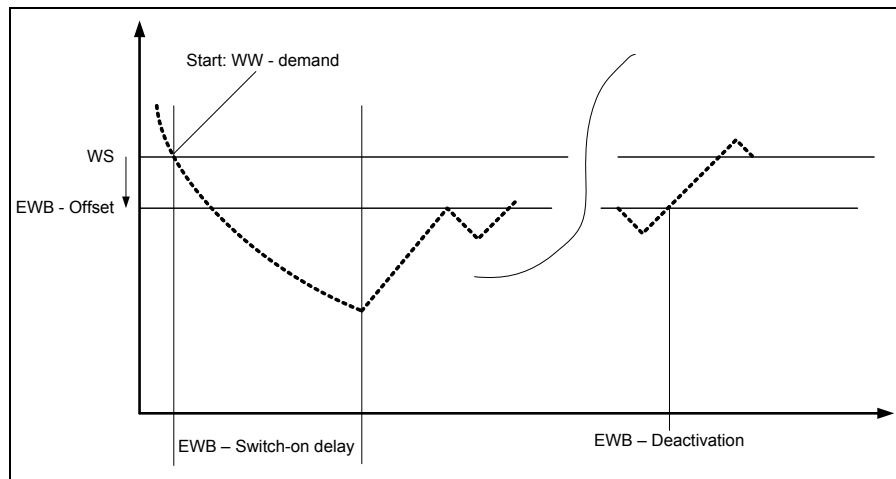

7.3.6 Solar/Solid fuel/Buffer

7.3.6.1 Solar function

Function The solar function makes it possible to combine solar power systems with heating and hot-water production systems in order to support the economy of the system. The solar loading pump can be controlled according to various switching conditions.

NOTE This function can only be called up, if a configurable switching output was occupied with a solar loading pump.

Two separate sensor inputs are available for the connection of the sensors:

- KVLf for the solar collector sensor
- KSPF for the collector tank sensor

For heat metering, an optional collector return sensor (KRLF) can be connected via a variable input (VI1 - VI3).

NOTE The solar loading pump is disabled if the collector flow sensor is defective.

Solar switch-on differential (switching differential ON)
With sufficient solar heat energy, the temperature differential between collector flow and tank will become bigger than the set value and the solar loading pump is switched on to load the buffer tank. The minimum set value is 3 K above the switch-off differential.

Solar switch-off differential (switching differential OFF)
If the temperature differential between the collector flow and tank falls below or equal to the set value, the solar loading pump is switched off and loading terminated. The maximum set value is always 3 K below the selected switch-on differential.

Minimum runtime of solar loading pump (SOP) The activated solar loading pump remains in operation for this set time. The minimum runtime has priority over the switch-off differential (switching differential OFF).

Collector maximum temperature limit This limit is used for thermal protection of the collector and causes forced switch-on of the solar loading pump if the set value is exceeded. If the temperature drops below the set value -5 K, all solar functions become active again based on their settings.

Solar tank maximum temperature limit If the temperature in the solar tank (hot-water tank or buffer tank) exceeds the set value, an active forced switch-on of the solar loading pump (see description for collector maximum temperature limit) is interrupted. This forced switch-on is enabled again as soon as the solar tank temperature falls more than 10 K below its set limit.

Solar control mode This function defines the solar loading mode.

Solar priority mode (disabling of heat generator)

During solar loading, all demand for the heat generator is suppressed.

Solar parallel operation

During solar loading, demand for the heat generator is permitted.

Solar priority mode - hot water (setpoint control)

During solar loading, demand for the hot-water control at the heat generator is suppressed.

Solar priority mode - buffer (setpoint control):

During solar loading, demand for the buffer control at the heat generator is suppressed.

Heat generator cycle disable Heat generator cycle disable (only with solar control mode = priority mode)

The cycle disable serves to prevent frequent switching between solar loading and loading by the heat generator. After a solar loading pump switch-off, the set time has to pass before the solar buffer tank can be loaded again by the heat generator (boiler).

Parallel switch-over **Solar priority/parallel switch-over (only with solar control mode = priority mode)**

Operation in hot-water priority mode

If the actual hot-water temperature undershoots the hot-water setpoint by the set amount, solar priority mode is cancelled until the hot-water setpoint has been reached.

Example:

Hot-water setpoint is 50°C, set value switch-over: 10 K.

There is no demand for the heat generator until the hot-water temperature drops below 40°C.

Operation in buffer priority mode

If the actual buffer temperature undershoots the buffer setpoint by the set amount, solar priority mode is cancelled until the buffer setpoint has been reached.

Example:

Setpoints at buffer of heating circuits: 45°C

Buffer offset: 10 K

Switch-over set value: 20 K

There is no demand for the heat generator until the buffer temperature drops below 35°C.

Heat balancing Heat balancing is activated through a parameter setting. The user can select between flow calculation via the pump runtime and determination of the flow volume via the pulse signal input of the device, if such an input is available. Any commercial flow meter can be connected to the pulse input.

Reset heat balancing (only if heat balancing is activated)

With this function, the heat balancing counter can be reset when heat balancing is activated.

Volume flow (only if heat balancing is activated)

This set value allows choosing between volume flow computed in

- litres/minute for calculating the flow volume or
- litres/pulse when using the pulse input corresponding to the respective pumping capacity of the solar loading pump.

NOTE With set value 0 L/min., no calculation of heat balancing is possible.

Density of medium (only if heat balancing is activated)

This set value defines the fluid density of the heat carrier medium used according to the manufacturer data.

Heat capacity Specific heat capacity medium (only if heat balancing is activated)

This set value defines the specific heat capacity of the heat carrier medium used according to the manufacturer data.

NOTE The physical values of volume flow, density and specific heat capacity form the basis for determining the solar heat balancing and the solar power and are calculated according to the mathematical relation

$$W = (V/t) \cdot \rho \cdot cW \cdot \Delta\delta \cdot tSOP$$

The results can be seen on the information level.

W = Heat balancing

V / t = Volume flow of the heat carrier medium

ρ = Density of the heat carrier medium

cW = Specific heat capacity of the heat carrier medium

$\Delta\delta$ = Temperature differential (collector flow/return)

Anti-blocking function This is an automatic function of the controller. If the solar loading pump was switched off longer than 24 hours, it is operated for approx. 20 seconds to prevent blocking via corrosion.

7.3.6.2 Buffer tank function

NOTE This function is only active if a buffer loading pump is assigned to a programmable switching output or if a buffer sensor has been connected to a variable input.

For stratified discharge, an optional second buffer tank sensor (PF2) can be connected to a variable input (VI1 to VI3).

The heat generator temperature is supplied by the temperature measuring device of the heat generator.

Function Buffer or energy tanks are used for storing energy that is available without control (e.g. from solar power system or wood boilers). This energy buffer covers the energy demand from heating circuits and hot-water systems.

Additional energy demand can be covered by controlled heat generators (boilers).

The buffer loading pump function ensures that a controlled heat generator supplies the additional energy to the buffer tank or the heating and hot-water circuits, respectively.

If no controlled heat generator is used (e.g. heating by wood boilers only), buffer functions such as forced dissipation into the heating circuits can be used by connecting and activating buffer sensor 1 to a variable input.

Control modes To support the full range of available combination options in multivalent heating systems with buffer support, the control system offers the possibility to set various control modes for buffer operation. The different settings cause different processing sequences of heat demand for heating circuit and hot water. In the following, the different control modes are illustrated using exemplary hydraulics layouts.

Control mode 1 – Loading control for heating circuit and hot-water demand

System hydraulics

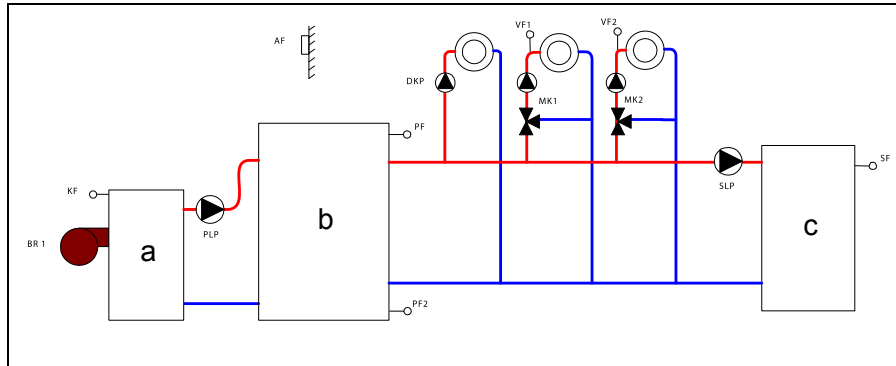

- a Heat generator
- b Buffer tank
- c Hot-water tank

Heating circuit and hot-water controls send their demand values to buffer control. Buffer control demand additional energy from the heat generator via the buffer loading pump.

See the table below for detailed correlations.

Control mode 2 – Loading control for heating circuit demand

System hydraulics

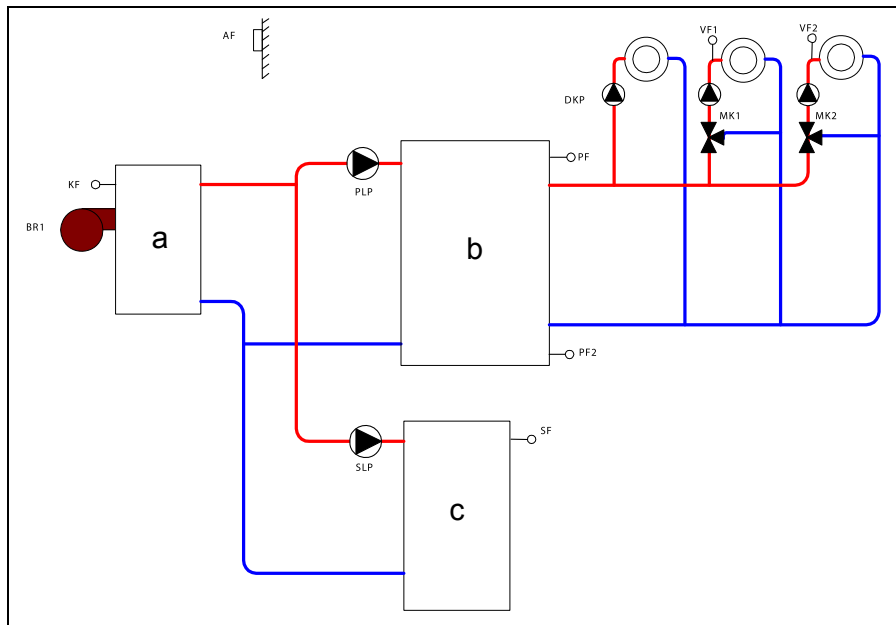

- a Heat generator
- b Buffer tank
- c Hot-water tank

Heating circuit controls send their demand value to buffer control. Hot-water and buffer controls demand energy from the heat generator when required.

With hot-water priority activated, this function acts on the buffer loading pump and not on the heating circuits.

See the table below for detailed correlations.

Control mode 3 – Discharge control for heating circuit and hot-water demand

System hydraulics

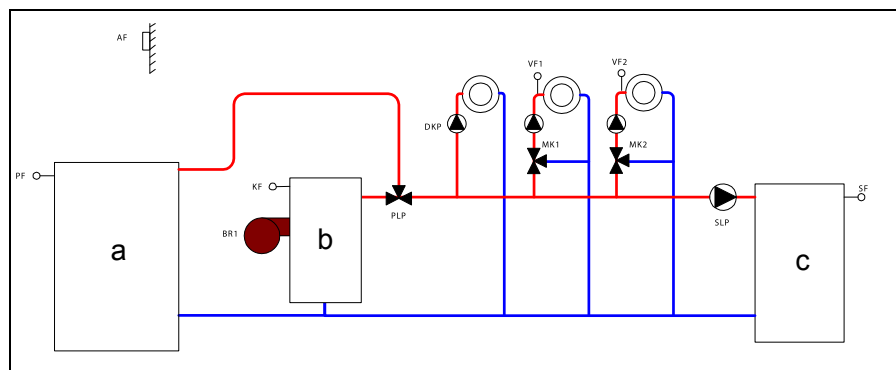

a Buffer tank

c Hot-water tank

b Heat generator

Heating circuit and hot-water controls send their demand value to buffer control. The buffer loading pump output switches ON when the energy demand can be met by the buffer. If the energy in the buffer is insufficient, buffer control demands additional energy from the heat generator and the buffer loading pump switches OFF.

If there is no demand for the heating circuits and hot-water loading, the buffer loading pump switches off.

See the table below for detailed correlations.

Control mode 4 – Discharge control for heating circuit demand
System hydraulics

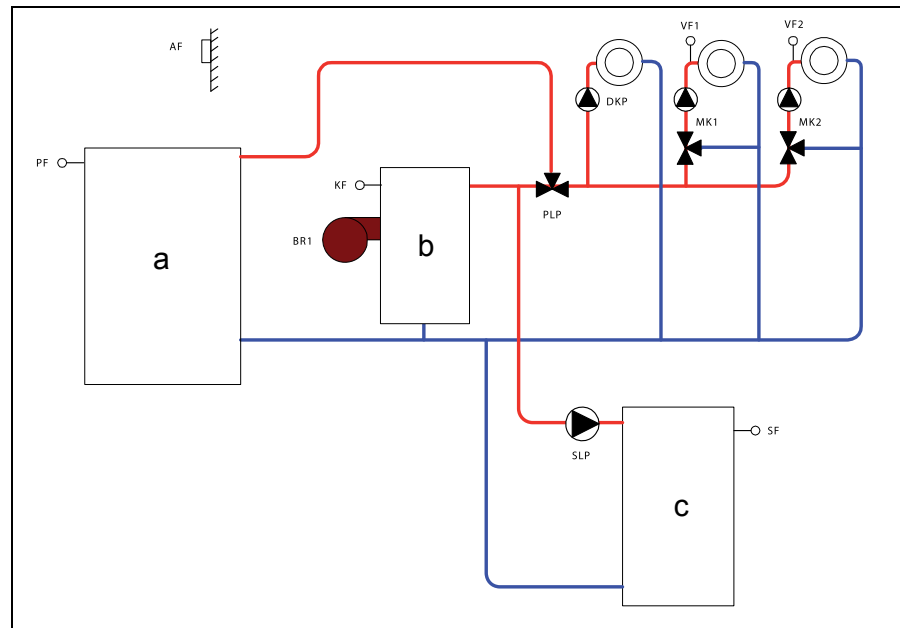

- a Buffer tank
- b Heat generator
- c Hot-water tank

As control mode 3, except that the demand from hot-water control are sent directly to the heat generator.

An active hot-water priority only acts on the heating circuits when there is no buffer discharge in progress.

See the table below for detailed correlations.

Control mode 5 – Loading control with hot-water switch-over valve
System hydraulics

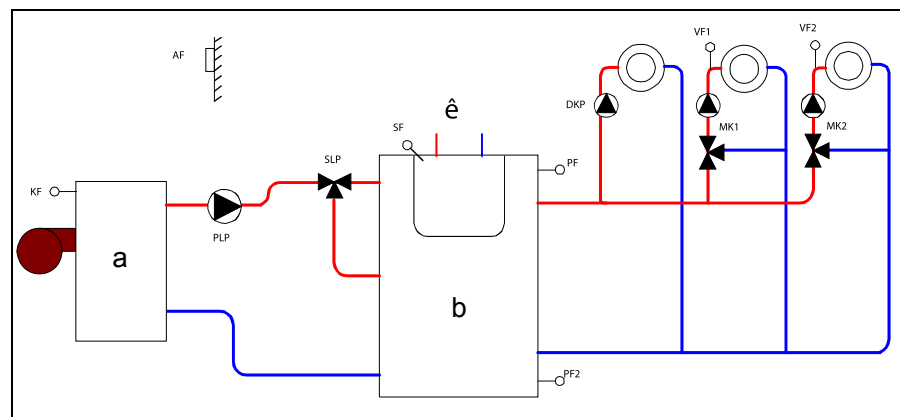

- a Heat generator
- b Buffer tank

Heating circuit controls send their demand value to buffer control. Hot-water and buffer controls demand energy from the heat generator when required. The buffer loading pump output is ON during buffer discharge and hot-water loading.

Any active hot-water priority is not effective here.

Control mode 6 – Discharge control to heat generator

System hydraulics

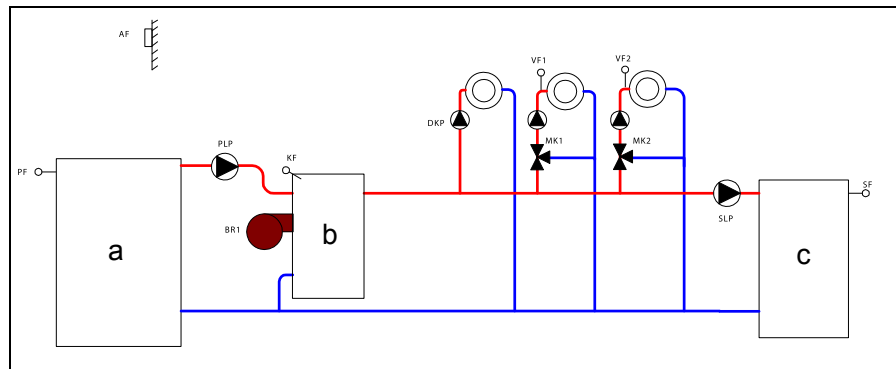

a Buffer tank

c Hot-water tank

b Heat generator

This hydraulic layout is used when an alternative-energy buffer tank is added to an existing system. In such systems it is often the case that there are existing unit boilers with integrated hot-water circuit loading tank and hot-water loading in the boiler.

All heat demand is forwarded to the heat generator.

When the buffer tank can cover the energy demand, the heat generator nominal temperature is maintained by the buffer via buffer loading pump instead of the burner.

In this way the heat generator always operates at its setpoint temperature and cannot be exposed to excessive buffer temperatures.

See the table below for detailed correlations:

	Buffer control mode					
	1	2	3	4	5	6
Buffer demand from	HC/HW	HC	HC/HW	HC	HC	–
Heat generator demand from	BUFFER	BUFFER/ HW	BUFFER	BUFFER/ HW	BUFFER/ HW	HC/HW
Buffer control mode	Load	Load	Dis-charge 1	Dis-charge 1	Load	Dis-charge 2
Buffer start-up protection acts on	HC/HW	HC	HC/HW	HC	HC	–
Buffer discharge protection	X	X	–	–	X	–
Buffer frost protection monitoring	X	X	–	–	X	–
Buffer minimum temperature monitoring	X	X	–	–	X	–
Buffer maximum temperature monitoring	X	X	X	X	X	X
Buffer forced dissipation into:	HC/HW	HC	HC/HW	HC	HC	HC/HW
Buffer siphon function	X	X*	–	–	X*	–
Loading temperature offset acts from:	HC/HW	HC	–	–	HC	–
Heat generator start-up protection on buffer loading pump	X	X	–	–	X	–
Buffer loading pump with no demand	OFF	OFF	OFF	OFF	OFF	OFF
Buffer loading pump for manual operation	ON	ON	OFF	OFF	ON	OFF
Buffer loading pump function for sensor defect	ON	ON	OFF	OFF	ON	OFF
Buffer loading pump function for heat generator disable	–	–	ON	ON	–	–

	Buffer control mode					
	1	2	3	4	5	6
Buffer loading pump function if heat generator is not available and buffer start-up protection is active	–	–	OFF	OFF	–	–
Buffer loading pump function if heat generator is not available and buffer start-up protection is not active	–	–	ON	ON	–	–
Action of heating generator start-up protection on heating circuits (HDCCP, MC1, MC2):	No	No	Yes	Yes	No	Yes
Action of heat generator start-up protection on hot-water circuit (tank loading pump)	No	Yes	Yes	Yes	No	Yes
Action of heat generator start-up protection on buffer loading pump	Yes	Yes	No	No	Yes	No

Loading control

The supply of energy from a controlled heat generator to the heating circuits is realised through loading the buffer. The buffer control ensures that the buffer is supplied with sufficient energy from the heat generator, via the buffer loading pump.

With buffer discharge controls, it must be ensured that the residual energy from the buffer can be transported to the heating circuits if a controlled heat generator is not available. With control mode 3 and 4, the buffer loading pump output must be switched for this purpose in this case. With control mode 6, only the burner demand is suppressed with a heat generator disable.

If a heat generator is not available and the actual buffer temperature is below the minimum buffer temperature while buffer start-up protection is active, the buffer loading pump output remains switched off (priority).

A heat generator is not available if:

- An external heat generator disable is active at a variable input
- Heat generator cycle disable is active via configuration in the "Solid Fuel" menu, parameter 05
- Heat generator cycle disable is active via configuration in the "Solar" menu, parameter 07
- A heat generator is not present in the system (e.g. purely solid fuel buffer combinations)

Discharge control 1

The heating circuits are supplied with energy either from the buffer through discharging the buffer tank via buffer loading pump, provided the buffer tank contains sufficient energy, or through direct supply from the heat generator.

NOTE If a heat generator disable is active (e.g. through external burner disabling via contact, cycle disable (solid fuel/solar)), the energy contained in the buffer, independent of the current buffer level, is dissipated into the heating circuits by enabling the buffer discharge channel (e.g. switching on the buffer loading pump or switching over the buffer loading pump valve). The buffer minimum temperature is monitored. Hot-water loading is enabled under the conditions of buffer/tank discharge protection.

Discharge control 2

The heating circuits are always supplied with energy from the heat generator. As long as the buffer contains sufficient energy, the heat generator will be heated via the buffer loading pump instead of the burner. If the energy in the buffer is not sufficient, the burner will be started.

NOTE If a heat generator disable is active (e.g. through external burner disabling via contact or cycle disable (solid fuel/solar)), this will only result in the suppression of the demand for the burner.

Buffer setpoint temperature The buffer setpoint temperature is the temperature that the buffer tank has to provide for supplying the connected heating circuits. It corresponds to the highest demand value of these heating circuits.

Example:

Demand value MC1 = 45°C

Demand value MC2 = 55°C

Demand value hot water = 65°C

=> buffer setpoint temperature = 65°C

A required offset value (e.g. hot-water load temperature offset) has already been taken into consideration in the demand value of the heating circuits.

Buffer minimum temperature limit When there is heat demand for the buffer tank from the heating circuits or from hot water, this request will be maintained at least to the minimum temperature limit. When the temperature drops below this limit, the buffer tank is recharged by the heat generator under the conditions of the buffer start-up protection.

Buffer tank maximum temperature limit If the buffer tank temperature exceeds the set value of the buffer tank maximum temperature limit, forced switch-off of the buffer loading pump occurs. The excess heat is dissipated into the selected circuits (see forced dissipation). Forced dissipation is disabled and buffer operation is resumed when the temperature in the buffer tank drops more than 2 K under the set maximum temperature limit.

<i>Buffer temperature offset of heat generator</i>	To ensure an adequate control reserve for all consumers connected to the buffer tank, the demand value sent to the heat generator can be raised by an additional temperature offset.
<i>Buffer switching differential</i>	If the buffer tank temperature rises above the current demand value by the set amount, the buffer loading pump is switched off. The pump is switched on again as soon as the buffer tank temperature drops below the current demand value.
<i>Buffer forced dissipation</i>	If the set buffer maximum temperature limit is exceeded, the excess energy can be dissipated into the heating circuits and the hot-water tank. The heating circuits into which the forced dissipation is routed are determined by the respective parameter.

Set value OFF

No heat dissipation

Tank loading pump (with provision tanks only)

Dissipation of the excess heat occurs to an existing water heater.

▲ ATTENTION

Use a thermal mixing valve in accordance with the regulations, as there is a risk of scalding.

Heating circuit pump(s)

Any excess heat is dissipated into the heating circuit(s). The set maximum temperature is not exceeded here. The intended room temperature may be exceeded for short periods.

NOTE Activate the thermostat function in conjunction with room station(s).

▲ ATTENTION

With floor heaters, use a system thermostat for pump forced switch-off.

Buffer siphon function Whenever the buffer tank is not being loaded by the heat generator (buffer setpoint reached) the differential between the heat generator temperature and the buffer tank temperature is measured continuously if configured to do so. The buffer loading pump is switched on as soon as the temperature differential rises above the set extended running switch-on differential. The buffer loading pump is switched off immediately when the temperature differential drops to the extended running switch-off differential.

This siphon function ensures that excess energy in the heat generator (e.g. due to extended heating) will not be lost.

Buffer start-up protection When operating a heating system without buffers, boiler start-up protection is generally implemented via temporary separation of the energy consumers from the heat generator (switch-off of pumps, close mixed heating circuits).

With buffer operation, there is no start-up protection for the heat generator acting on the heating circuits. The start-up protection only acts on the buffer loading pump. If the buffer minimum temperature is undershot when the buffer start-up protection is switched on, all consumer circuits (heating circuits, hot water) are separated on the water side (pumps switch off). The buffer start-up protection is disabled (pumps are switched on again) when the buffer temperature exceeds the buffer minimum temperature plus half of the buffer switching differential. All consumer circuits remain in operation when buffer start-up protection is switched off.

With operation in conjunction with buffer tanks, the hydraulic conditions for each buffer control mode deviate from this. Special considerations must be made regarding boiler start-up protection for this reason.

Buffer start-up protection can be switched off.

Buffer discharge protection Buffer discharge protection disables the buffer loading pump until the heat generator temperature has risen to more than 5 K above the buffer setpoint temperature.

This function helps prevent rear buffer discharge through the heat generator. The buffer loading pump is disabled again as soon as the temperature differential between the heat generator and the buffer tank has dropped to less than 2 K.

For operation without buffer tanks, tank discharge protection ("Hot Water" menu, parameter 08) acts on the heat generator. The heat generator sensor and the hot-water circuit sensor are compared.

Depending on the activated buffer control mode, activated tank discharge protection must act on the buffer instead of the heat generator. The required conditions can be seen in the following table.

	Buffer control mode					
	1	2	3	4	5	6
Tank discharge protection/heat generator available	Buffer	Heat generator	Heat generator	Heat generator	Heat generator	Buffer
Tank discharge protection/heat generator not available	Buffer	Heat generator	Buffer	Heat generator	Heat generator	Buffer

Buffer sensor 2 (BS2) Buffer sensor 2 (BS2)

As an option, the buffer tank can be equipped with the second buffer sensor (BS2) via the variable inputs, for stratified loading. The buffer is loaded through the active heat generator as soon as the higher temperature (of the two sensors) undershoots the setpoint value. Loading through the heat generator is terminated when the lower temperature (of the two sensors) has reached the setpoint plus the set buffer switching differential (stratified loading)

Buffer loading pump extended running time

When buffer loading of a buffer loading system is complete, an extended running time for the buffer loading pump can be configured via a parameter setting.

7.3.6.3 Solid fuel function

NOTE This function can only be called up, if a configurable switching output was occupied with a solid fuel loading pump.

The following sensors can be used for control:

- SFS for the solid fuel boiler sensor
The connection occurs automatically depending on the assignment of the output to VI1 or VI2.
- SFS for the solid fuel buffer sensor (optional)
The connection occurs to variable input 1 – variable input 3 depending on the assignment to an available variable input.
- If no solid fuel buffer sensor is connected, the collector tank/buffer sensor value (dedicated sensor input) is accepted as the buffer sensor. In this way, the collector tank/buffer sensor input can be used as a sensor input for several uncontrolled heat generators (e.g. solar or solid-fuel).

▲ ATTENTION

Note the sensor position and stratification conditions.

A forced switch-on will be initiated for the solid fuel loading pump if a solid-fuel boiler sensor is defective.

Function The solid-fuel function allows the integration of solid-fuel boilers (usually in combination with a buffer tank) into the system to support heating. Under this function the solid fuel loading pump can be controlled through various switching conditions as described in the following.

Solid-fuel boiler minimum temperature limit If the temperature in the solid-fuel boiler rises 10 K above the set value, the solid-fuel loading pump is enabled.
If the temperature in the solid-fuel boiler undershoots the minimum boiler temperature, the solid-fuel loading pump is switched off and loading is interrupted.

Solid-fuel boiler maximum temperature limit If the temperature in the solid fuel boiler rises above the set maximum temperature limit, the solid-fuel loading pump is forced to switch on. The excess heat is then dissipated into the preselected circuits (see "Buffer Tank" menu). This forced dissipation will be cancelled and the temperature differential control enabled when the solid-fuel boiler temperature undershoots the maximum limit by more than 10 K.

Solid-fuel boiler buffer tank switch-on differential (switching differential ON) If the temperature in the solid-fuel boiler rises above the current temperature in the buffer tank by at least the set amount, the solid-fuel loading pump is switched on and the buffer tank is loaded.

Prerequisite:

The temperature of the solid-fuel boiler is at least 10 K over the minimum temperature limit.

The **min.** set value is 3 K above the switch-off differential.

Solid-fuel boiler buffer tank switch-off differential (switching differential OFF) If the differential between the solid-fuel boiler and buffer tank temperatures is less than the set amount, the solid-fuel loading pump is switched off and loading is interrupted. The **max.** set value is constantly 3 K below the selected activation difference in order to prevent rear discharging of the buffer tank.

Heat generator cycle disable

Heat generator solid-fuel cycle disable

The solid-fuel cycle disable serves to prevent frequent switching between loading through the solid-fuel boiler and loading through a conventional oil/gas heat generator.

After the solid-fuel loading pump has been switched off, the set time must pass before loading of the buffer tank is continued through the conventional heat generator.

Anti-blocking function This is an automatic function of the controller. If the solar loading pump was switched off longer than 24 hours, it is operated for approx. 20 seconds to prevent blocking via corrosion.

7.3.7 Tank loading switch-over

In systems that have both an external hot-water tank and a buffer tank, a diverter valve can be used to switch between loading the hot-water tank and loading the buffer tank from solar power system. This allows economical and effective use of solar power

to support heating during periods when less solar power is available.

To ensure that the solar tank in priority operation (temperature sensing by the sensor of the solar loading switch-over, usually hot-water tank) can be loaded, checks are performed at regular intervals to determine whether sufficient solar power is available (meaning the solar panel temperature is sufficiently high for loading and the set switch-over temperature can be reached).

Diverter valve This function allows switching of a diverter valve according to the load condition of two heat storage tanks (two-point output) so that solar energy can be used to support heating during periods of low solar intake.

Test cycle If the switch-over condition is not fulfilled after a preset time interval of 30 minutes (meaning the temperature in the first-priority tank remains below the set switch-over temperature) and if the loading conditions for the second-priority tank (temperature sensing by the collector tank/buffer sensor, usually buffer tank for heating support) are fulfilled, the solar loading pump (SOP) is temporarily switched off after the time set in the "Solar" menu, parameter 15. During the switch-off time, the differential between the collector flow sensor (SPFS) and the sensor for solar loading switch-over (SLVF) is determined. If the switch-on condition is fulfilled, the first-priority tank is loaded. If the loading condition is not fulfilled after the set time, loading is continued into the lower priority tank as long as the loading conditions are not fulfilled.

These cyclical checks are suspended if the temperature at the solar loading switch-over sensor plus the switch-on differential becomes greater or equal the set final switch-off temperature.

Solar loading switch-over operation

Only a setting option if a solar loading pump is set on the hydraulic level.

7.3.8 Hydraulic buffer relief (HBR)

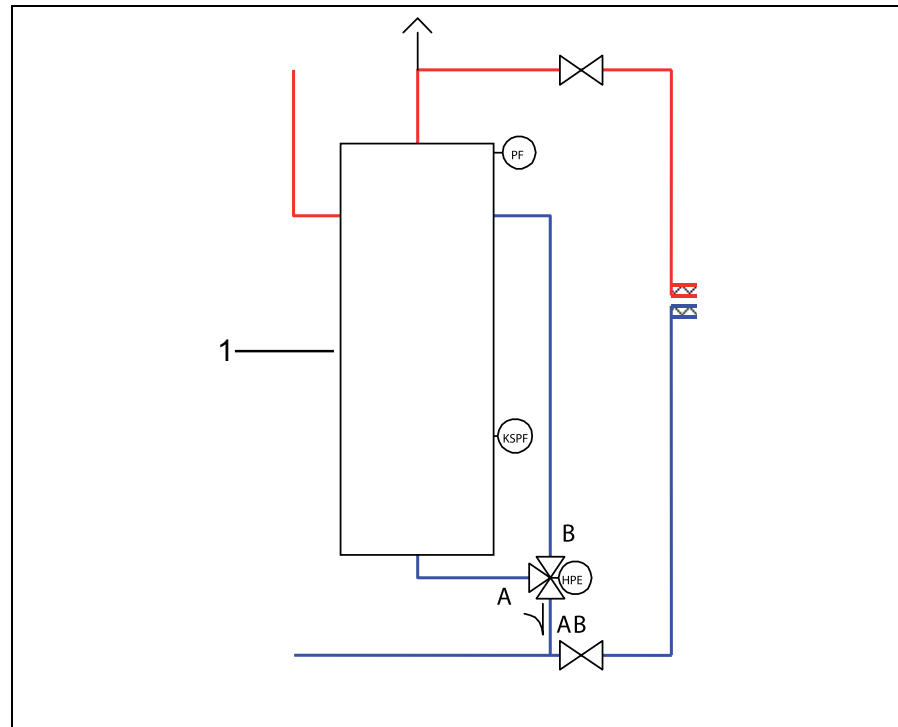

1 Buffer tank

Function Using a 3-way switching valve (output active), hydraulic buffer relief (HBR) causes temporary intake into the upper region of the buffer tank, if that region has not reached its setpoint temperature yet, so that connected heating or hot water circuits receive priority supply of energy.

When the buffer temperature exceeds the buffer setpoint by 2.5 K, the 3-way switching valve is hydraulically coupled to the lower region of the buffer tank so that the entire buffer tank can be loaded. Another switch-over to the upper region of the buffer tank is initiated as soon as the buffer temperature undershoots the buffer setpoint temperature by 2.5 K.

Application Partial buffer loading with priority supply for heating and hot water for all types of loading control modes (see buffer control modes 1, 2 and 5)

Hydraulic function If the output is deactivated (de-energised), the buffer is loaded (valve position A–AB, discharge deactivated).
If the output is activated (energised), only the top region of the buffer is loaded (valve position B–AB, discharge activated)

Switching differential: SDHPE: 5 K (fixed)
Switch-on: Buffer setpoint
Switch-off: Buffer setpoint +5 K

7.3.9 Easy enabling and disabling of a heating pump

The stages of the heat generator (then heating pump) should be able to switch off below a settable outside temperature.

Setting range OFF, -20 – +30

Special handling of heat generator version, setting 3:

With a setting of heat generator type 3 (2x single-stage), special handling with regard to the outside temperature disable occurs so that a heating pump can be combined with supplemental heat generators. Below a set outside temperature, the heat pump (first heat generator) is then disabled, but the supplementary heater (second heat generator) remains enabled.

- If no "inverse outside temperature disable" was configured ("Heat Generator" menu, parameter 38 = OFF), a configured "outside temperature disable" ("Heat Generator" menu, parameter 25) occurs on both heat generators.
- If an "inverse outside temperature disable" was configured ("Heat Generator" menu, parameter 25 not OFF), the "inverse outside temperature disable" acts on the first heat generator (stage 1) and the "outside temperature disable" acts on the second heat generator (stage 2).

NOTE A separate boiler sensor (BS2) must be configured for the second heat generator.

7.3.10 Other system components

7.3.10.1 Global fault message input

Function Activating this function causes the corresponding input to act as a switching contact. With the contact closed (short-circuited), the fault message input is treated as an additional fault in the control system. Intruding fault messages can thus be forwarded via the data bus or taken into account via an additional fault message output.

Up to three different fault messages can intrude via variable inputs.

7.3.10.2 Global fault message output

NOTE This function must be activated in the "Hydraulics" menu for a variable output (VO1 or VO2).

Function The function becomes active on detection of fault messages of any kind. It serves as a global fault message output for connecting optical or acoustic alarm signal devices.

7.3.10.3 Timer

NOTE Only active if setting "14" (timer) was selected for parameter 05 (direct heating circuit pump output) in the "Hydraulics" menu.

Function This function controls a consumer according to the current switching time program of the direct heating circuit.

7.3.10.4 External switching modem

Function Only activated if setting 11 (external switching modem) was selected for parameter 08, 09 or 10 (variable inputs) in the "Hydraulics" menu.

This configuration allows switching between control modes via the telephone using a switching modem to be provided by the user (for holiday homes etc.).

Assignment A switching modem can be assigned to each of the three variable inputs (VI1 ... VI3). If a variable input is assigned this function, the associated parameter appears in the "System" menu for assignment of the switching modem to the respective heating circuit. The same parameters and areas are involved here as with the demand contact, i.e. the modem acts either on the direct circuit (DC), mixed heating circuit 1 (MC1), mixed heating circuit 2 (MC2), hot-water circuit (HW) or the entire system (ALL), i.e. globally on all central devices on the data bus system.

The control mode depends on the wiring at the respective variable input in the following way:

Connection terminal of variable input 1 (2, 3) open:

Control based on the current control mode (AUTO, RED. HEATING, HEATING, STANDBY)

Connection terminal of variable input 1 (2, 3) short-circuited:

Control functions in standby mode; heating and hot water are switched off frost protected.

Connection terminal of variable input 1 (2, 3) with terminating resistor with 10 kOhm

Control based on continuous heating.

Connection terminal of variable input 1 (2, 3) with terminating resistor with 2.2 kOhm

Control based on continuously reduced operation (according to specification as reduced or switch-off mode).

NOTE Only one modem can be connected to each control device.

In case of simultaneous access to a heating circuit, the following rules apply:

- If multiple variable inputs are configured to the same heating circuit, the priority is as follows: variable input 1, variable input 2, variable input 3.
- If a variable input is assigned to ALL, it has a higher priority than a heating circuit assignment
- If multiple variable inputs are configured to ALL, the priority is again as follows: variable input 1, variable input 2, variable input 3.

▲ ATTENTION

Short-circuit or terminating resistor may be connected to GND (ground) only.

7.3.10.5 External information

Function A temperature value sensed by a standard sensor is displayed as an information value in the information display. This function is controller-independent and is for information only

7.3.10.6 Demand contact

NOTE This function is active for a demand contact if "demand contact" was selected for a variable contact and a heating circuit function was assigned to the associated output. The heating circuit functions are: mixed heating circuit, direct heating circuit, constant controller and fixed-value controller.

Function If a variable input (see note) was defined as a demand contact, the corresponding parameter for assigning the contact to the respective heating circuit (i.e. the heating circuit to be addressed by the demand contact) is displayed in the "System" menu.

The setting range includes all control circuits within a controller (DC, MC1, MC2, HW or ALL) so that the demand contact can be assigned either to each individual heating and hot-water circuit or, if required, to all circuits.

▲ ATTENTION**No global controller function for data bus system with several central devices.**

Control modes and switching time settings are not effective when the demand contact is activated. The respective heating circuit only responds to requests from the demand contact.

The control modes manual, emission measurement with safety temperature limiter check and screed function are of higher priority.

System information

An open demand contact is signaled by the string "disable" in the status display; a closed contact is identified by the string "demand".

- Contact function** A variable input that has been defined as a demand contact acts on the heating circuit in the following way:
- Variable input open: **No demand**
The heating circuit is switched off unconditionally (no frost protection, no standby function).
 - Variable input short-circuited: **Demand**
The heating circuit is in control mode HEATING (continuous heating) and works according to its parameter settings.

▲ ATTENTION**Customers must take appropriate frost protection measures for the respective control circuit.**

This function can be activated up to three times (once for each available variable input).

7.3.11 Bus communication

7.3.11.1 Bus address of central device

Function Control devices SDC and DHC 43 can be connected via a data bus. This makes it possible

- to control additional heating circuits by adding up to four additional central devices.
- to connect wall devices to the central devices and assign heating circuits.
- to cascade multiple heat generators with one built-in central device each.

The following figure shows the maximum possible expansion stage of the bus system.

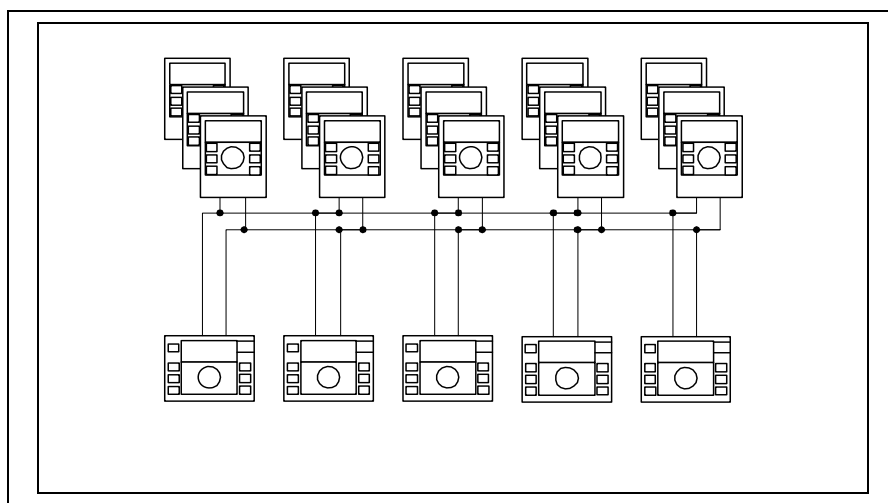

The individual devices in the SDC/DHC 43 bus system contain a unique address. It is set in the corresponding parameter in the "Data Bus" menu. Assignment is carried out using the table below.

Address	Device type	Assignment
10	SDC/DHC 43	Central device 1 as "base unit"
20	SDC/DHC 43	Additional central device 2
30	SDC/DHC 43	Additional central device 3
40	SDC/DHC 43	Additional central device 4
50	SDC/DHC 43	Additional central device 5

NOTE There must always be a control device with the bus address 10 in the bus system.

Note that bus addresses can only be issued once. Duplicated addresses cause problems on the data bus.

7.3.11.2 Control functions via the data bus

7.3.11.2.1 Boiler start-up protection

If the selected heat generator operates with boiler start-up protection, it signals the status of start-up protection to all the corresponding heating circuits. They block the energy tapping (pumps off, mixed heating circuit closed) for the period of the start-up protection.

7.3.11.2.2 Indirect return increase

The heat generator in the base unit (addr. 10) transmits its current boiler data, and each mixed heating circuit in the system can carry out indirect boiler return increase.

7.3.11.2.3 Tank control mode (tank priority operation)

Each central device can carry out hot-water circuit loading. For loading in priority operation, hot-water circuit loading that has been started disables all other heating circuits and hot-water circuit loading within the bus system. If tank loading occurs in parallel operation, all heating circuits in the system remain active and an additional hot-water circuit loading with set parallel operation can be activated.

7.3.11.2.4 Heating circuit demand

Each heating circuit demand within the data bus system is processed by the base unit (addr. 10). It takes on the greatest demand and passes it on to the heat generators as a setpoint value. A selected manual mode with manual temperature specification also counts as demand.

7.3.11.2.5 Clock synchronisation

The time of day is sent to the entire system by the base unit (addr. 10). There is a system time.

7.3.11.2.6 Room temperature transmission

The wall devices send their current room temperature to the assigned heating circuit at regular intervals.

7.3.11.2.7 Fault messages/Status indications

Fault messages and status indications are sent from the central device to the associated wall units and displayed there.

7.3.11.2.8 Examples with multiple control devices

Example 1 Heating system with a two-stage heat generator, industrial water production and four mixed heating circuits. The following diagram shows the hydraulics of this system.

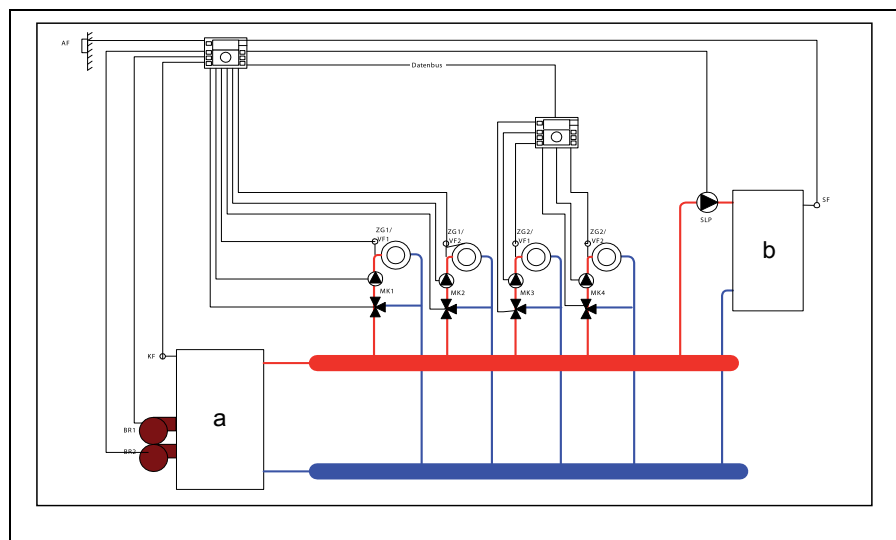

a Boiler

b Hot-water tank

The following components are connected to the first controller with bus address 10:

- Outside sensor
- Stages 1 and 2 of the burner
- Boiler sensor
- Tank sensor
- Tank loading pump
- Mixed heating circuit pump, mixed heating circuit open/closed and flow sensor of heating circuit 1
- Mixed heating circuit pump, mixed heating circuit open/closed and flow sensor of heating circuit 2

The following components are connected to the second control device with bus address 20:

- Mixed heating circuit pump, mixed heating circuit open/closed and flow sensor of heating circuit 3
- Mixed heating circuit pump, mixed heating circuit open/closed and flow sensor of heating circuit 4

Example 2 Heating system with a two-stage heat generator, two mixed heating circuits and two industrial water loadings (used, for example, for a duplex with one heat generator). The following diagram shows the hydraulics of this system.

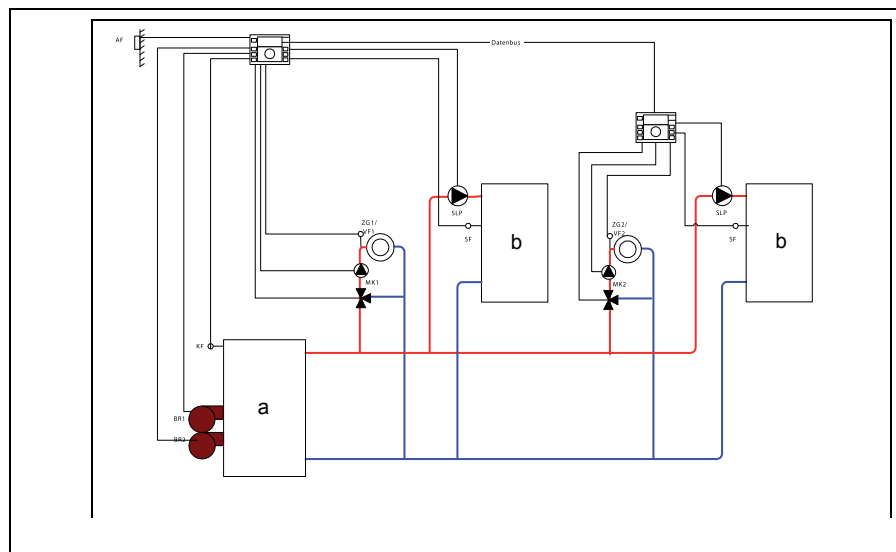

a Boiler

b Hot-water tank

7.3.11.2.9 Correction of the heat generator after the total flow temperature

Total flow sensor The sensor connected to variable input 1 (2, 3) measures the total flow temperature in thermohydraulic distributors or in the common flow.

Correction of the boiler temperature no longer occurs based on the measured temperature of the boiler sensor, but rather based on the total flow sensor. The boiler sensor still checks the boiler minimum and maximum temperatures of the heat generator.

Using a PI control algorithm, the behaviour of the heat generator can be influenced by a deviation between the total flow setpoint temperature and the total flow actual temperature.

The PI controller can be influenced via three setting options:

- P-part: Proportional part of the controller
- Sample time: The sample time is a controller-internal value which defines the time interval between two subsequent actuator pulses in the presence of a control deviation.
- Adjustment time: The adjustment time determines the dynamic behaviour of the controller based on the set sample time.

Important note for parameter setting:

The factor for the I-part within the controller is related to the parameter setting values as follows:

(K_i = factor for the I-part, T_a = sample time, T_n = adjustment time)

$$K_i = K_p \frac{T_a}{T_n}$$

Example

Initial values:

- P-part = 0.5%/K
- Sample time = 20 sec.
- Adjustment time = 600 sec.
- Total flow setpoint (w) = 68°C
- Total flow actual value (x) = 53°C

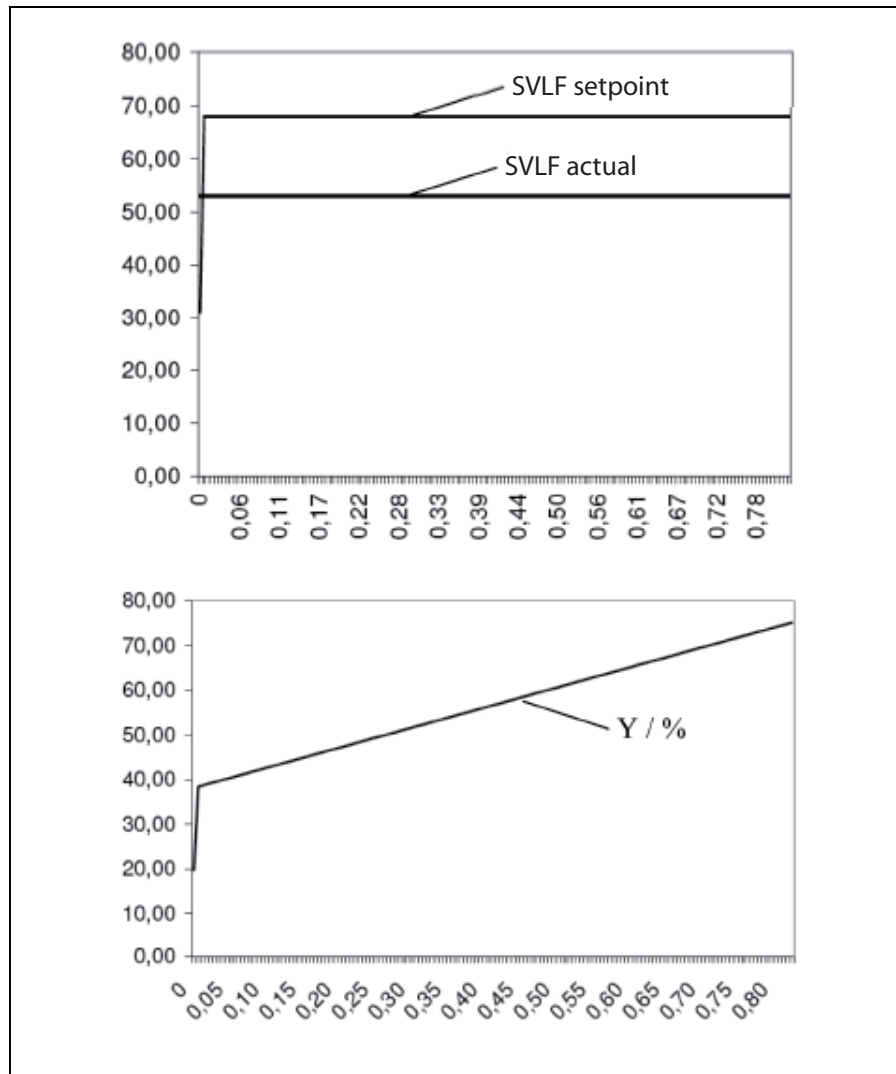

7.3.11.3 Operation of wall devices

7.3.11.3.1 Operation of digital wall device SDW 30

Function A digital wall device SDW 30 can be connected to the control device. Parameterization is done at the central device in the "direct heating circuit" or the "mixing heating circuit", parameter 03.



With a digital wall device, remote control for a central device (e.g. from a living room) is possible in addition to the room temperature detection. Settings can be carried out for all the existing heating circuits.

The bus address of the wall device is used to specify the heating circuit on which the room sensor (room influence) is to act.

When an SDW 30 is connected for the first time to the bus system, the address is selected for the heating circuit to which the SDW 30 is to be assigned (bus address).



After the input has been confirmed, feedback of the heating circuit (DC, MC1, MC2) and the central unit (CU) to which the digital wall device has been assigned is output.

Assignment is carried out on the basis of the following table:

Address	CD address	Assignment
11	10	CU 1 – Direct heating circuit
12	10	CU 1 – Mixed heating circuit 1
13	10	CU 1 – Mixed heating circuit 2
21	20	CU 2 – Direct heating circuit
22	20	CU 2 – Mixed heating circuit 1
23	20	CU 2 – Mixed heating circuit 2
31	30	CU 3 – Direct heating circuit
32	30	CU 3 – Mixed heating circuit 1
33	30	CU 3 – Mixed heating circuit 2
41	40	CU 4 – Direct heating circuit
42	40	CU 4 – Mixed heating circuit 1
43	40	CU 4 – Mixed heating circuit 2
51	50	CU 5 – Direct heating circuit

Address	CD address	Assignment
52	50	CU 5 – Mixed heating circuit 1
53	50	CU 5 – Mixed heating circuit 2

▲ ATTENTION

Double assignments of bus addresses are not permissible and inevitably lead to errors in data transmission and thus to faulty control behaviour of the heating system.

Changing bus addresses

A bus address can be changed at a later time using the following procedure:

- Disconnect wall devices from the data bus line (disconnect plug connection at the bottom of the device)
- Reconnect the wall device, holding the input button pressed down until the address setting screen is displayed.
- Set and confirm the new bus address.

7.3.11.3.2 Operation with wall device SDW 10

Function A wall device SDW 10 can be connected to the control device. Parameterization is done at the central device in the "direct heating circuit" or the "mixing heating circuit", parameter 03.

With an SDW 10, it is possible to detect the room temperature, adjust the room setpoint temperature and change the control mode for a heating circuit remotely. The settings only apply for the assigned heating circuit.

The bus address of the wall device is used to specify on which heating circuit the room sensor and the adjustment of the control mode are to act.

The connection is carried out via the data bus.

Setting the bus address The address of the SDW 10 is set by means of the rotating encoding switch on the inside of the wall device in accordance with the following table:

Address	CU address	Assignment
0	Undefined	Undefined
1	10	CU 1 – Direct heating circuit

Address	CU address	Assignment
2	10	CU 1 – Mixed heating circuit 1
3	10	CU 1 – Mixed heating circuit 2
4	20	CU 2 – Direct heating circuit
5	20	CU 2 – Mixed heating circuit 1
6	20	CU 2 – Mixed heating circuit 2
7	30	CU 3 – Direct heating circuit
8	30	CU 3 – Mixed heating circuit 1
9	30	CU 3 – Mixed heating circuit 2
A	40	CU 4 – Direct heating circuit
B	40	CU 4 – Mixed heating circuit 1
C	40	CU 4 – Mixed heating circuit 2
D	50	CU 5 – Direct heating circuit
E	50	CU 5 – Mixed heating circuit 1
F	50	CU 5 – Mixed heating circuit 2

Current room temperature sensing The integrated room sensor determines the current room temperature for all the room temperature-related functions and transfers them to the central device every 20 sec.

Control mode selection The desired control mode is selected with the input button (press and hold approx. 2 – 3 seconds) and indicated by the corresponding LED. When the button is pressed, the control mode is adjusted in the following sequence:

AUTOMATIC MODE – HEATING – LOWERING – AUTOMATIC MODE - ...

After control mode selection, the selected control mode is transferred to the central device. Only the control mode of the heating circuit to which the SDW 10 is assigned is transferred.

Automatic mode The heating circuit is controlled constantly in accordance with the specification of the automatic program P1 – P3 set in the central device plus or minus the room setpoint correction at the input button.

Heating The heating circuit is controlled constantly in accordance with the desired daytime room temperature plus or minus the room setpoint correction at the input button.

Reduction The heating circuit is controlled constantly in accordance with the reduced room temperature plus or minus the room setpoint correction at the input button. The function depends on the setting in the parameter selection for the heating circuit (reduced parameter).

Room setpoint correction The input button can be used to modify the room temperature set at the central device by +/-6 K referenced to the central position.

Turn clockwise: Temperature increase

Turn anti-clockwise: Temperature decrease

Display The indicator display is comprised of three LEDs. The possible states are listed in the table below:

Control mode/Function	Moon LED	Clock LED	Sun LED
Automatic	OFF	ON	OFF
Permanent heating	OFF	OFF	ON
Permanent reduction	ON	OFF	OFF
Start-up phase	BRIEF FLASHING	BRIEF FLASHING	BRIEF FLASHING
Error at address setting	FLASHING	ON	ON
Bus fault as well as indication when parameters are disabled	ON	FLASHING	ON
Party (can be set via central device)	OFF	OFF	FLASHING
Absent (can be set via central device)	FLASHING	OFF	OFF
Holiday (can be set via central device)	OFF	Flash	OFF

Definition:

Flashing:  0.8 sec. on and 0.8 sec. off

Brief flashing:  0.08 sec. on and 0.7 sec. off

Flash:  0.08 sec. on and 1.4 sec. off

The operation indication is updated immediately after adjustment when adjusted at the SDC 10 and at the latest after about 20 sec. after adjustment when adjusted at the central device.

NOTE In all other control modes not defined in the table above, all three LEDs are activated.

7.3.11.3.3 Wall Module TF 22 / TFU 22

Configuration and allocation is done via parameter 08, 09 or 10 in the "Hydraulic" menu. For any of the signals "Room temperature" and "Setpoint" one variable input must be assigned.

The parameter setting in the "Hydraulic" menu for room sensor is 30 (for direct heating circuit), 31 (for mixing circuit 1) or 32 (for mixing circuit 2). The parameter setting in the "Hydraulic" menu for "Setpoint deviation" and "Operating mode" is 50 (for direct heating circuit), 51 (for mixing circuit 1) and 52 (for mixing circuit 2). Electrical connection occurs according to the assignment to variable input 1 (VE1) ... variable input 3 (VE3) (Wall socket).

Example Assignment of TF 22 to mixing circuits 1 (room sensor to VE1 and setpoint / operating mode to VE2).

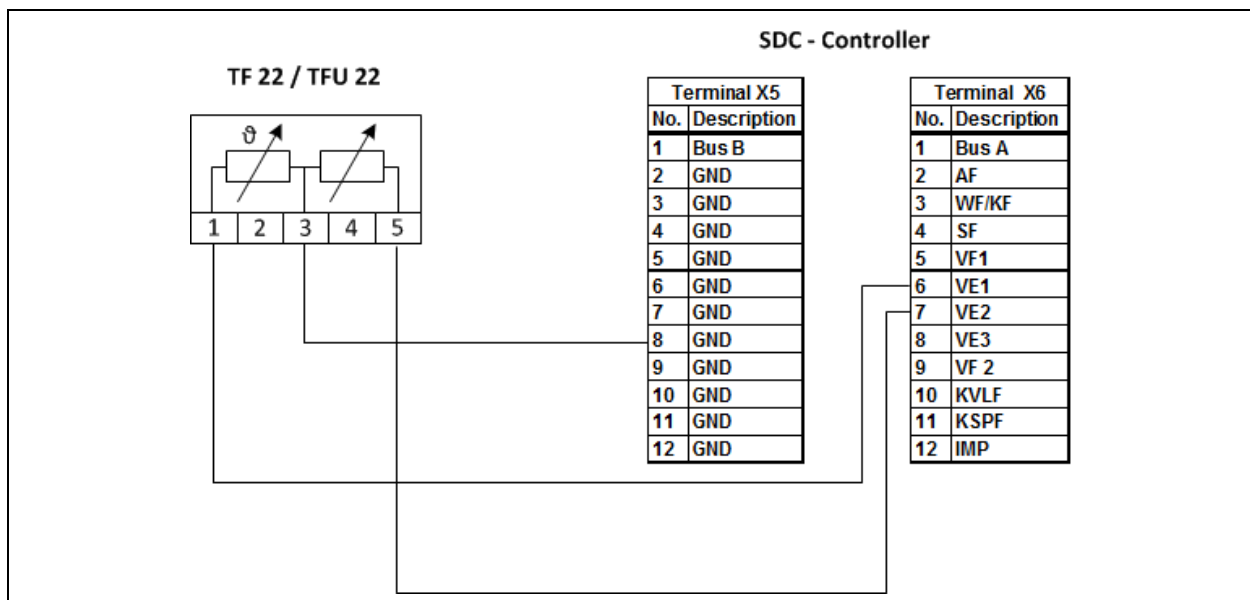

1 Actual value

3 GND

5 Setpoint and operating mode

7.3.11.3.4 Operation with NTC 20K room temperature sensor

Instead of the RFF, an NTC 20 room sensor can be connected to a sensor input (VI1-VI3).

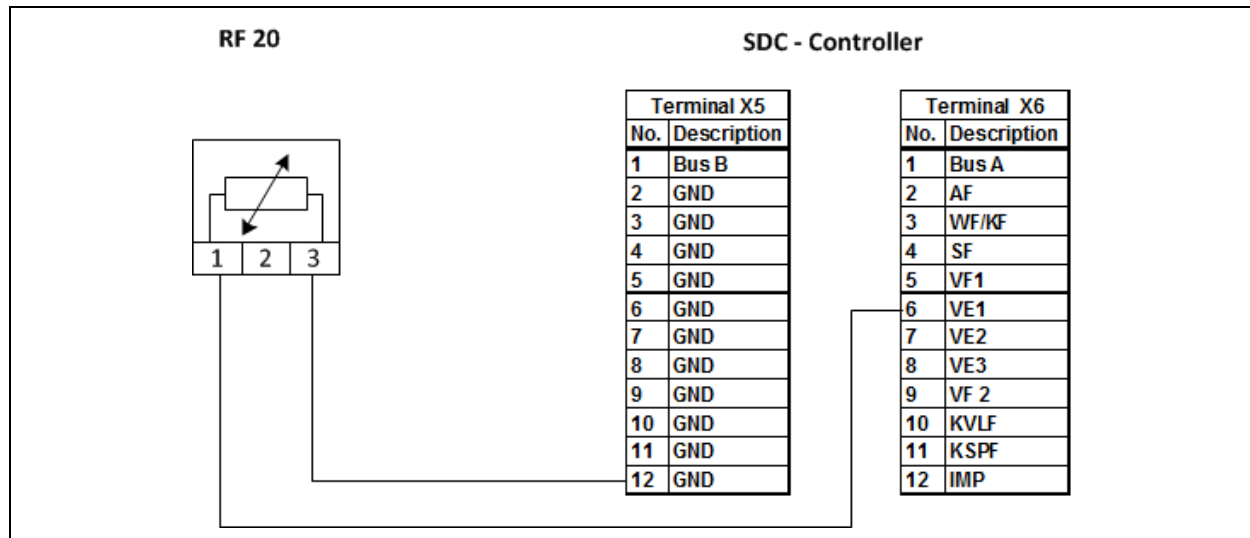

1 Actual value

3 GND

Function Configuration is carried out in the "Hydraulics" menu, parameter 08, 09 or 10.

Assignment to the heating circuit to be acted upon by the room sensor is carried out via a fixed heating circuit assignment using parameter settings (e.g. 30 = DC, 31 = MC1, 32 = MC2)

The combined operation of an NTC 20 room sensor and an SDW 10/SDW 30 room sensor for a heating circuit is not possible. If an SDW 10/SDW 30 room sensor is connected, it always has first priority. In this case, the NTC 20 room sensor has no effect. With operation via a connected SDW 30 (room sensor with no effect), an NTC 20 room sensor can be combined with a variable input. With an NTC 20 room sensor connected, all room functions of the heating circuit are in effect ("Direct Heating Circuit", "Mixed Heating Circuit 1" or "Mixed Heating Circuit 2" menu, parameter 4 = active). In conjunction with the NTC 20 room sensor, this means a shift of the controller (software) to the central device. The configuration of the room controller with NTC 20 room sensor operation occurs via additional parameters in the central device menu trees DC/MC1/MC2. The room controller in the SDW 30 functions as before. Room control in conjunction with SDW 10 is not possible.

7.3.11.3.5 Heating circuit bus authorisation

Function This setting serves to determine the authorisation status of a room station connected to a heating circuit. One parameter per available heating circuit is available for this setting.

Set value **Simple access authorisation**

Only switching times and parameters of the **specific** heating circuit concerned can be read and modified. On call-up, only the information for the heating circuit concerned are displayed to the respective user (operator).

Application Tenant status

Extended access authorisation

This authorisation status allows access to **all** heating circuits and to the hot-water circuit and their parameters and switching times within the respective central device

Application Landlord status

NOTE Once a wall device is connected and registered via the data bus to the central device, the central device automatically switches to remote operating mode! This is necessary to ensure clear operation of the system with connected wall devices.

7.3.12 Cascading of heat generators in the bus system

7.3.12.1 General description of cascading of control devices

Function In its standard version the control system features the possibility to couple and cascade several boilers. The cascade control is independent of the type of heat generators to be combined. For instance, condensing boilers can be easily combined with atmospheric gas boilers.

The system automatically recognises a cascade by checking if several central devices have programmed a heat generator, or if more than one condensing boiler is connected to a central device. In cascade operation an additional cascade selection level is displayed for handling the parameters in the central device assigned to bus address 10.

The cascading function can be switched off ("Cascade" menu, parameter 5 = OFF). In this case, only the outside temperature will be transferred via data bus.

NOTE Cascade operation excludes 2-stage boiler control. All available stages are operated by the cascade management. Consequently, the respective parameters of the "Heat Generator" menu are not available. All control is now governed by cascade control.

7.3.12.2 Function of the cascade parameters

- Switching differential* Each heat generator has its own switching differential. The cascade switching differential must be set in such a way that it is always larger than the switching differential of any individual heat generator.
- Connection delay* The afterheating characteristics of the boilers used must be taken into account when rating the heating system. The cascade switch-on delay is used to adjust the system to the start-up delays of the individual boilers. When does the heat generator deliver its energy into the system after being switched on (start-up phase, pre-running time)? The appropriate setting is the maximum delay time of the boilers in the system.
- Deactivation delay* To prevent all heat generators switching off simultaneously if the set cascade switching differential is exceeded, the run-down of heat generators is controlled by the switch-off delay. The setting has to be adjusted to the afterheating characteristics of the heat generators.
- Stage reversal* To ensure the balanced utilisation of the heat generators within a cascade, a runtime-dependent leading stage swap can be activated.
- After the set operating time of the presently leading heat generator has passed, the system switches to the heat generator with the next higher bus address.
- Stage swap can only be executed between several central devices. It cannot be applied if several condensing boilers are switched by a single central device.
- Guidance stage* The leading cascade stage can still be set manually to any existing stage even when automatic stage-sequence switching is disabled.

NOTE Changing the heat generator type within the central device at address 10 leads to an automatic reset of the leading stage to the first heat generator.

7.3.12.3 Mode of operation of cascade control

7.3.12.3.1 Switch-on characteristics

The switch-on characteristics of the boiler stages are determined by the set switching differential and the dynamic switch-on delay. The stage number is incremented only when the following criteria are fulfilled:

$$BT_{ACTUAL} < BT_{SETPOINT} - SD/2$$

$$t \geq t_{\text{Switch-on delay}} * (100 - (dVT * 100 / VLSetpoint)) / 100$$

$$Stages_{Number} = Stages_{Selection}$$

The boiler temperature of the leading boiler or the total flow sensor must have exceeded the specified boiler setpoint minus half of the switching differential (switch-on delay time) for at least the calculated switch-on delay. Additionally, the requested stage number must have been sent to central device 10 as the active status response.

The additional boiler stages can be switched on by using a fixed time delay (Switch-off of the dynamically determined switch-on delay).

This can be used for the fixed control of the switch-on delay of an additional heat generator, e.g. of a heat pump. Therefore, in the Heat Generator menu, the parameter 39 must be adjusted to a value of 1..300 min.

7.3.12.3.2 Switch-off characteristics

The stage number is decreased again as soon as the temperature of the leading boiler or of the total flow sensor exceeds the present setpoint boiler temperature plus half of the switching differential for at least the calculated switch-off delay time.

$$BT_{ACTUAL} > BT_{SETPOINT} - SD/2 \text{ or } BT_{ACTUAL} \geq BT_{MAX}$$

$$t \geq t_{\text{Switch-on delay}} * (100 - (dVT * 100 / VLSetpoint)) / 100$$

$$Stages_{Number} = Stages_{Selection}$$

7.3.12.3.3 Control characteristics

- The heat generator that was switched on last adjusts the system to the set nominal temperature.
- All other heat generators operate at the set maximum temperature (base load).
- The boiler stage number can be reduced as soon as the adjusting stage has withdrawn its demand to the heat generator and the boiler temperature has risen above the setpoint temperature plus the set switching differential.
- For each heat generator the displayed setpoint temperature always is the currently demanded temperature to be adjusted to.
- A heat generator that is not available in the system (malfunction, external disable or outside temperature disable) is ignored within the stage sequence. The next available heat generator will be switched on instead.

7.3.12.3.4 Delay, enabling, full load in cascade operation

The switch-over power set within the cascade selection level is only intended for the operation of automatic stokers. As long as the last burner stage is not started, all burner stages up to that point which are currently operating are reduced to the specified switch-over power (power limit). When switching on the last burner stage, all other automatic stokers are enabled to 100% power (full load) after another progression of the dynamically determined switch-on delay (at least 5 min.).

If the system is operating with all available stages, no power limit is active for the automatic stokers. If a level is reduced, the set switch-over power for the automatic stokers is once again in effect.

Grouping for base and peak loads (ANF118-V2.2 specifications)

High quality, expensive condensing boilers are used for the base load, especially with gas systems. During cold months, low-temperature boilers are used for covering peak loads. It is necessary that an activated stage reversal only affect the base load boiler here. The peak-load boilers are excluded from the stage reversal.

Function The configuration defines which peak load heat generator is the first one (all heat generators with addresses greater than or equal to the setting).

The time-based stage reversal (see "Cascading" menu, parameter 05) only affects the connected base-load boiler (smaller address setting).

The first peak-load boiler is not switched on until the base-load boilers are operating at 100%.

If grouping was carried out via the configuration and the peak-load boiler was in demand, a change of the leading group can be activated via a parameter. If this parameter is set to ON, the group of peak-load boilers take over the base load upon demand and the base-load boilers take over adjustment of the flow temperature. Further switching of stages is still only active for the actual base-load boilers.

7.3.12.3.5 Special function characteristics

Manual mode The heating circuits of the control device in which manual operation was activated, operate according to the manual function. The set demand value is forwarded to the energy management module of cascade control and adjusted to by the available boiler stages.

Emission measurement This function works as described under "Emission measurement", with the following extensions:

- The effect on heating circuits is extended to all heating circuits of the system.
- Enabling of the heat generators (burner) is initiated at the same devices where emission measurement was activated.

<i>Safety temperature limiter</i>	<p>This function works as described under "Safety temperature limiter check", with the following extension:</p> <p>As soon as a safety temperature limiter function is detected within the BUS system, all consumers (heating circuits) are disabled.</p>
<i>Emergency mode</i>	<p>Configuration of cascade control occurs in the central device with the bus address 10. If that controller becomes unavailable due to some defect, the remaining stages continue operating in an emergency mode. In this mode all heat generators adjust to the same boiler setpoint temperature (parallel operation). As soon as the cascade manager comes back into operation, cascade control is reactivated automatically.</p>
<i>Data transmission</i>	<p>To enable the cascade function to process fast switching events, the cascade data are transferred with a higher priority. Consequently, the data transmission from any device to the master device, and of the request values from the master to the slave devices, takes no longer than approx. 3 seconds.</p>

7.3.13 Commissioning, maintenance and troubleshooting help

7.3.13.1 Automatic set function

Function The central devices are equipped with a function which ignores unused sensors and control functions. Fault messages from non-connected sensors are not displayed.

The AUTO SET function is only active at power up. There are two possibilities for calling up the AUTO SET function.

Automatic call-up If the commissioning date has not yet been stored and the corresponding system parameters for activating this function are set to ON, connected or disconnected sensors are registered automatically whenever the control device is switched on. Fault messages from sensors (short-circuit interruption) are suppressed in this period. After the commissioning date has been saved, a change to the sensor configuration is only still possible after the manual SET function. The AUTO SET function can be enabled at any time again for a day (day change) using the system parameter.

Manual call-up Manual call-up of the AUTO SET function is always possible. The call-up is activated by pressing the input button during the version display until the AUTO SET function is shown in the display. The basic display is activated after the function has been carried out.

A change in the function assignment by the AUTO SET function is only carried out depending on the following inputs and selected configuration:

Input		Only executed if:	
Outside sensor	(AF)		
Flow sensor 1	(VF1)	MC1:	OFF/Mixed heating circuit valve
Flow sensor 2	(VF2)	MC2:	OFF/Mixed heating circuit valve
Tank sensor	(SF)	SLP:	OFF/Tank loading pump
Boiler sensor	(KF)	BR:	OFF/Single-stage

The current setting values are checked beforehand so that the configuration carried out is not changed by the AUTO SET function. A change is only carried out if one of the settings specified above is applicable. This ensures that the AUTO SET function cannot, for example, ever log off a return increase at the MC2 or re-function it into a mixed heating circuit.

7.3.13.2 Emission measurement (not for DHC 43)



By pressing this key, the heat generator is controlled for 20 minutes according to the maximum temperature limit. The remaining time is displayed and counted down.

With two-stage heat generators, both stages are in operation (measurement at nominal power).

Function The heat generator is adjusted to the maximum heat generator temperature. All heating circuits and the hot-water production adjust their setpoint to the respective maximum temperature.

▲ ATTENTION

There is danger of scalding because the hot-water temperatures may rise above the setpoint temperature.

Application Emission measurement via chimney sweep

Cancellation Emission measurement can be terminated at any moment in advance with the  key.

Safety check Safety temperature limiter check may be performed only by the technician

Function By keeping the input button  pressed during an emission measurement, the integrated heat generator maximum temperature limit is bypassed and the heat generator remains in operation continuously until the safety temperature limiter (STL) is triggered. During the safety temperature limiter check, all the consumers are separated from the heat generator, i.e. any available mixed heating valve is closed and all the heating and hot-water loading pumps are stopped. The emission measurement is continued from the moment of termination with the previously saved remaining time.



Application Safety temperature limiter check by the heating technician

Cancellation Release the input button. The emission measurement still active is stopped with the  key.

7.3.13.3 Relay/function test

Function Depending on the controller version, various outputs can be tested. This is not only a relay test, but a function test by means of which the hydraulic components are tested. The partially compulsory sequence of the switching procedures is considered here.

After selecting the test function, the relevant relays can be switched one after the other by pressing the input button  in the specified switching sequence.

Heat generator Heat generator test

Single-stage heat generator

("Heat Generator" menu, parameter 1 = 1)

Switching sequence: OFF, ON, OFF ...

2-stage heat generator

("Heat Generator" menu, parameter 1 = 2)

Switching sequence: OFF, STAGE 1, STAGE 1+2,
STAGE 1, OFF ...

2x single-stage heat generators

("Heat Generator" menu, parameter 1 = 3)

Switching sequence: OFF, HG 1, HG 1+2, HG 2, OFF ...

Modulating mode

("Heat Generator" menu, parameter 1 = 4)

Switching sequence: OFF, ON, OPEN, STOP, CLOSED,
OFF ...

Pumps/VOs **Pump test**

(Direct heating circuit pump, mixed heating circuit pump, tank loading pump, variable output 1, variable output 2)

Switching sequence OFF, ON, OFF, ...

Mixer motor: Mixed heating circuit actuator test

Switching sequence STOP, OPEN, STOP, CLOSED,
STOP ...

Function For easier diagnosis by the technician, a test run that detects implausibilities in the system has been implemented.

The jump occurs via an additional item in the relay test. The test run is started by pressing the input button. The sensor test sequence is similar to the final device test.

Value	Range
OT	-50°C – 40°C
VF	10°C – 90°C
SF	5°C ... 90°C
RT (SDW 10/SDW 30)	0°C ... 40°C
SVLF	5°C – 90°C
SBUS	5°C – 90°C
VF1 (evaluation as NTC 20, not PT 1000)	5°C – 90°C
VF2	5°C – 90°C
VF3	5°C – 90°C

Confirmation is required for each sensor value. All available inputs are checked. Unoccupied inputs are marked with "-".

Meaning	Display
Value OK	80°C
Value outside the sensible range	IRR
Short-circuit/Interruption	Error, –
Function programmed, but no sensor at input	Error, –
No function programmed, but a sensor is at input	Error

Bus test

The system configuration is conveyed via the SMILE BUS. Display occurs using an overview representation for a central device.

The following are displayed:

- Central devices in the system network
- Wall devices that are directly assigned to the corresponding central device

Display

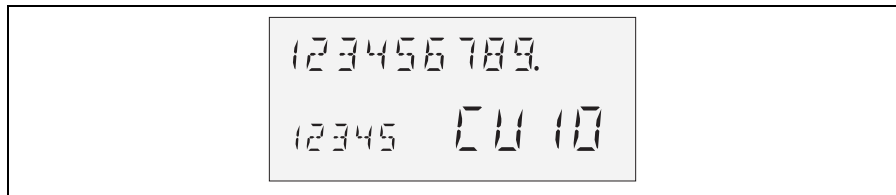

Bottom right: Address of the operated central device

Bottom left: Display of the control network (1 = ZG10, 2 = ZG20, 3 = ZG30)

Top: Display of the peripheral devices of operated central device 1, 2, 3 = wall devices DC, MC1, MC2 assigned to operated controller

Example:

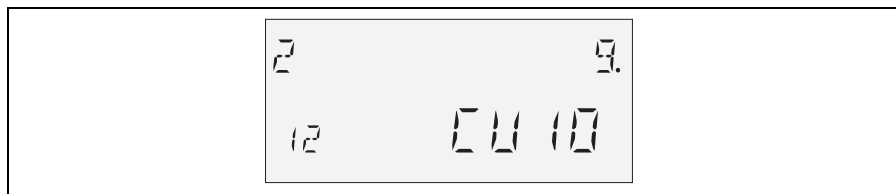

The central device is operated at address 10. Two central devices are found in the bus system (addr. 10 and 20). A wall unit MC1 is connected (addr. 12) to central device 10. An additional mode is found in the bus system (9).

7.4 Error messages

ATTENTION

Inform the heating technician whenever any fault messages are output.

The control device contains substantial error-notification logic. The error messages appear in continuous alteration with the basic display. Multiple errors that occur at the same time appear one after another in the order in which they occurred. The following types of error message exist:

Sensor error messages	Sensor measured values that do not lie in the measurement range are evaluated as an interruption or short-circuit. They appear depending on the type and allocation with fault code 10 to 20 and index 0 for short-circuit or 1 for interruption.
Heat generator error messages	These error messages evaluate the respective switching status. They appear depending on the type and allocation with fault code 30 to 40 and index 0, 1 or 2.
Logical error messages	These error messages evaluate the control result to be expected. They appear depending on the type and allocation with fault code 50 to 60 and index 0, 1 or 2.
Bus error messages	These error messages refer to address faults such as double issuance or non-recognition of address settings on the data bus. They appear with fault code 70 and index 0 or 1, depending on the type and assignment.

The display and further processing of logical fault messages can be suppressed through corresponding configuration.

Detected faults are proceed via:

- Display in the basic display of the controller
- System fault via display on the information level with the corresponding information value
- Inclusion in the fault log (see below for description)
- If activated, via switching of a fault message output
- Forwarding via the data bus

Fault messages				
Fault status	Designation	Fault type	Fault object code	Remark
System	Outside sensor	Interruption	10-0	
System	Outside sensor	Short-circuit	10-1	
System	Boiler sensor	Interruption	11-0	
System	Boiler sensor	Short-circuit	11-1	
System	Flow sensor 1	Interruption	12-0	MCP = off, MIMO = de-energised
System	Flow sensor 1	Short-circuit	12-1	MCP = off, MIMO = de-energised
System	Tank sensor	Interruption	13-0	
System	Tank sensor	Short-circuit	13-1	
System	VI-2	Interruption	14-0	
System	VI-2	Short-circuit	14-1	
System	VI-2	Fault message	14-7	
System	VI-3	Interruption	15-0	
System	VI-3	Short-circuit	15-1	
System	VI-3	Fault message	15-7	
System	VI-1	Interruption	16-0	
System	VI-1	Short-circuit	16-1	
System	VI-1	Fault message	16-7	
System	Buffer sensor of collector	Interruption	17-0	
System	Buffer sensor of collector	Short-circuit	17-1	
System	Flow sensor 2	Interruption	18-0	MCP = off, MIMO = de-energised
System	Flow sensor 2	Short-circuit	18-1	MCP = off, MIMO = de-energised
System	Flow sensor of collector	Interruption	19-0	
System	Flow sensor of collector	Short-circuit	19-1	

Fault messages				
Fault status	Designation	Fault type	Fault object code	Remark
System	Room sensor (RSC/RS)	Interruption	20-0	
System	Room sensor (RSC/RS)	Short-circuit	20-1	
System	Burner 1	No switch-off	30-2	
System	Burner 1	No switch-on	30-3	
System	Burner 2	No switch-off	31-2	
System	Burner 2	No switch-on	31-3	
System	Heat meter	No pulse	32-3	
System	Flue gas temperature	Overshoot	33-5	
System	Flue gas temperature	STL triggered	33-8	
logical	Boiler temperature	Not reached	50-4	
logical	Tank temperature	Not reached	51-4	
logical	Screed temperature	Not reached	51-7	
logical	MC1 flow temperature:	Not reached	52-4	
logical	MC2 flow temperature	Not reached	53-4	
logical	Room temperature HC	Not reached	54-4	
logical	MC1 room temperature	Not reached	55-4	
logical	MC2 room temperature	Not reached	56-4	
System	Address	Address collision	70-0	
System	Activity	No T2B signal	70-1	
System	EEPROM		71-0	
System	EEPROM defect		71-1	
System	FA	No signal	71-6	

Fault messages				
Fault status	Designation	Fault type	Fault object code	Remark
System	Master	Missing	71-8	
System	Pulse input fault	No signal	90-0	Fault message if no signal after 5 minutes
System	Fault	Lock	EnXX	Automatic stoker fault
System	Fault	Blocking	EnXX	Automatic stoker fault

Fault message log The control device has a fault message log in which a maximum of five fault messages can be saved. The fault messages are displayed with the date, time and fault type (fault number); the query is carried out in the sequence of the entered fault messages in the "Fault Message" menu.

The last (most recent) fault message is in first position (No. 01); the previous fault messages are shifted down by a position upon each new fault message. The fifth fault message is deleted when a new fault message appears.

If a heat generator defect occurs (fault message 30-1 or 31-3) and system frost protection is active at the same time, boiler start-up protection is switched off and thus the heating circuit pumps are started to minimise the danger of system freezing.

Fault message log expansion **Five fault messages from automatic stokers (condensing versions) with OpenTherm**

These fault messages come from automatic stokers and are categorised as either locks, blockages or warnings.

The display and further processing of logical fault messages from the SMILE system can be enabled or suppressed via a corresponding configuration (see "System Parameters" menu, parameter 13 (logical fault message)).

The display and further processing of fault messages from a connected automatic stoker can be controlled as follows.

Using parameter 27 in the "System Parameters" menu, you can specify which of the fault messages transmitted by an automatic stoker is forwarded to the SMILE system.

Using parameter 28 in the "System Parameters" menu, you can specify whether or not fault messages of an automatic stoker are

to be written to a separate fault memory. If the parameter is set to ON, another menu appears in the menu with the designation "Fault 2". Only faults of the automatic stokers are saved in this fault memory.

Additional fault processing:

Faults appear in the basic display of the controller. System faults appear on the information level with the corresponding information value. Faults may be copied to the fault message log (see below for description). If configured accordingly, faults activate a fault message output to the connection of an optical or acoustic transducer and are forwarded to the corresponding gateways.

With connection of an automatic stoker, further fault messages may arrive from it. They are displayed as follows:

Fault type	Fault code	Field 1	Field 2	Field 3
Water pressure	S0-1	Water pressure		HIGH
Water pressure	S0-5	Water pressure		LOW
Water pressure	S0-2	Water pressure		MIN
Ventilation	S1-0	Ventilation		
Maintenance	S2-0	Maintenance		
Switch-off	–	Switch-off		OFF
Service	240-1	Service		

Fault message log The control unit features two fault message logs (FAULT MESSAGE for system faults and FAULT 2 for faults from automatic stokers), in which max. 20 fault messages can be saved. The fault messages are displayed with their date, time and fault type (fault number). The query is carried out in the sequence of the entered fault messages in the "Fault Message" menu.

The last (most recent) fault message is in first position; the previous fault messages are shifted down by a position with each new fault message. The fifth fault message is deleted when a new fault message appears.

Operating information	Key/Menu	Parameter
Display of logical fault messages	SYSTEM	13
Fault memory inquiry	FAULT MESSAGE	ERR-1 . ERR-5

NOTE In the case of condensing systems with automatic stokers, the outside sensor input can be used to switch off the heating system. A sensor short-circuit at the outside sensor suppresses a fault message regarding this and switches off the system. The message "Heating system off" appears instead of the fault message in this case.

If a heat generator defect occurs (fault message 30-1 or 31-3) and system frost protection is active at the same time, boiler start-up protection is switched off and thus the heating circuit pumps are started to minimise the danger of system freezing.

7.4.1 Basic display/fault stack fault messages

With connection of an automatic stoker, further fault messages may arrive from it. They are displayed as follows.

Fault type	Fault code	Field 1	Field 2	Field 3
Water pressure	S0-1	Water pressure		HIGH
Water pressure	S0-5	Water pressure		LOW
Water pressure	S0-2	Water pressure		MIN
Ventilation	S1-0	Ventilation		
Maintenance	S2-0	Maintenance		
Switch-off	–	Switch-off		OFF
Service	240-1	Service		

7.4.1.1 Sensor calibration

Function If the measured values of the connected sensors do not match the actual temperatures, a comparison of the sensor values is possible in the "Sensor Comparison" menu. In this menu, all sensors connected to the device can be corrected by ± 5 K based on the factory calibration value.

The current measured value, plus or minus the correction made and the correction itself, appears in the display. The increment of the compensation is 0.5 K.

▲ ATTENTION

The sensor circuits are calibrated at the factory using precise measuring equipment. Compensation should only be carried out if you are sure that the amount of the deviation remains constant over the entire measurement range.

With sensor compensation, the respective amount must be noted down, as otherwise the factory setting is no longer valid and the reference value is lost.

The original factory setting cannot be restored via a reset!

Application

- Compensation in the case of very longer sensor cables
- Constant external temperature influence on sensors

7.4.1.2 Full controller reset

To revert the controller to its state of delivery, a full reset can be performed. Here, all parameters, values and counters accessible via the enabled code are reset and the controller is restarted.

Values that are not accessible via the set access code remain in tact.

Activation Press the , , and keys simultaneously

7.4.1.3 Controller time correction

In some special cases it may be necessary to adjust the runtime of the clock integrated in the controller. Please contact the manufacturer if necessary.

8 Technical data

8.1 General

Mains connection voltage	230 V +6 % / -10 %
Rated frequency	50 ... 60 Hz
Power consumption	max. 5.8 VA
Pre-fuse	max. 6.3 A slow-blowing
Contact load of the output relays	2 (2) A
Bus interface	For the connection of external devices (wall device, PC, modem or gateway)
Max. bus length	50 m
Power supply via bus	12 V/150 mA
Ambient temperature	0 ... +50°C
Storage temperature	-25 ... +60°C
Degree of protection	IP 30
Protection class as per EN 60730	II
Protection class as per EN 60529	III
Radio protection	EN 55014 (1993)
Interference resistance	EN 55104 (1995)
EC conformity	89/336/EEC
Housing dimensions	144 x 96 x 75 mm (W x H x D)
Housing material	ABS with static inhibitor
Connection technology	Plug-in screw terminal connections

8.1.1 Installation recommendations

Mains voltage lines (mains connection, burners, pumps, servo motors):	
Diameter	1.5 mm ²
Max. permissible length	No limit for installation in buildings.
Safety low-voltage lines (sensors, ext. switches upon demand via switching contact, modem connection lines, analog signal lines etc.)	
Diameter	0.5 mm ²
Max. permissible length	100 m (looped circuit); longer connection lines should be avoided to prevent the risk of interference
Data bus lines	
Diameter	0.6 mm ²
Max. permissible length	50 m (looped circuit, longest distance between a central device and a device to be supplied); longer connection lines should be avoided to prevent the risk of interference.
Recommended layouts	J-Y(St)Y 2 x 0.6

8.2 Sensor resistance values

8.2.1 NTC 20

For outside sensor (OT), heat generator sensor (BLRS/BS), tank sensor (DHWS), mixed heating circuit 1 flow sensor (VF1), mixed heating circuit 2 flow sensor (VF2), variable input 1 (VI-1) (setting not for exhaust gas sensor), variable input 2 (VI-2), variable input 3 (VI-3), collector tank/buffer sensor (SBUS).[^]

°C	Ω		°C	Ω		°C	Ω		°C	Ω		°C	Ω
-50.0	1659706		-9.0	115575		31.0	15180		71.0	2989		111.0	793.7
-49.0	1541379		-8.0	109189		32.0	14511		72.0	2882		112.0	770.3
-48.0	1432919		-7.0	103194		33.0	13875		73.0	2779		113.0	747.7
-47.0	1332091		-6.0	97564		34.0	13270		74.0	2681		114.0	725.8
-46.0	1238358		-5.0	92274		35.0	12695		75.0	2587		115.0	704.7
-45.0	1153525		-4.0	87303		36.0	12148		76.0	2496		116.0	684.2
-44.0	1073429		-3.0	82628		37.0	11627		77.0	2409		117.0	664.5
-43.0	999894		-2.0	78232		38.0	11131		78.0	2325		118.0	645.3
-42.0	932327		-1.0	74094		39.0	10659		79.0	2245		119.0	626.9
-41.0	869327		0.0	70200		40.0	10210		80.0	2168		120.0	609.0
-40.0	814000		1.0	66515		41.0	9781		81.0	2094		121.0	591.7
-39.0	759391		2.0	63046		42.0	9373		82.0	2022		122.0	575.0
-38.0	708806		3.0	59777		43.0	8983		83.0	1954		123.0	558.8

°C	Ω		°C	Ω		°C	Ω		°C	Ω		°C	Ω
-37.0	661924		4.0	56697		44.0	8612		84.0	1888		124.0	543.2
-36.0	618451		5.0	53793		45.0	8258		85.0	1824		125.0	528.0
-35.0	578119		6.0	51055		46.0	7920		86.0	1763		126.0	513
-34.0	540677		7.0	48472		47.0	7598		87.0	1705		127.0	499
-33.0	505902		8.0	46034		48.0	7291		88.0	1648		128.0	485
-32.0	473588		9.0	43733		49.0	6998		89.0	1594		129.0	472
-31.0	443546		10.0	41560		50.0	6718		90.0	1542		130.0	459
-30.0	415600		11.0	39500		51.0	6450		91.0	1491			
-29.0	389298		12.0	37553		52.0	6195		92.0	1443			
-28.0	364833		13.0	35714		53.0	5951		93.0	1396			
-27.0	342063		14.0	33975		54.0	5718		94.0	1351			
-26.0	320860		15.0	32331		55.0	5495		95.0	1308			
-25.0	301107		16.0	30775		56.0	5282		96.0	1266			
-24.0	282696		17.0	29303		57.0	5078		97.0	1226			
-23.0	265528		18.0	27909		58.0	4883		98.0	1187			
-22.0	249511		19.0	26590		59.0	4696		99.0	1150			
-21.0	234561		20.0	25340		60.0	4518		100.0	1114			
-20.0	220600		21.0	24155		61.0	4347		101.0	1079			
-19.0	207607		22.0	23032		62.0	4184		102.0	1046			
-18.0	195459		23.0	21967		63.0	4027		103.0	1014			
-17.0	184096		24.0	20958		64.0	3877		104.0	982.8			
-16.0	173463		25.0	20000		65.0	3734		105.0	952.8			
-15.0	163508		26.0	19089		66.0	3596		106.0	923.9			
-14.0	154185		27.0	18224		67.0	3464		107.0	896.0			
-13.0	145450		28.0	17404		68.0	3338		108.0	869.1			
-12.0	137262		29.0	16624		69.0	3216		109.0	843.1			
-11.0	129583		30.0	15884		70.0	3100		110.0	818.0			
-10.0	122380												

8.2.2 PT 1000

For variable input 1 (VI-1) (setting of exhaust gas sensor),
collector flow sensor (SPFS)

°C	Ω		°C	Ω		°C	Ω		°C	Ω		°C	Ω
-40.0	842.7		1.0	1003.9		41.0	1159.3		81.0	1312.8		121.0	1464.5
-39.0	846.7		2.0	1007.8		42.0	1163.1		82.0	1316.6		122.0	1468.2
-38.0	850.7		3.0	1011.7		43.0	1167.0		83.0	1320.4		123.0	1472.0
-37.0	854.6		4.0	1015.6		44.0	1170.9		84.0	1324.2		124.0	1475.8
-36.0	858.6		5.0	1019.5		45.0	1174.7		85.0	1328.0		125.0	1479.5
-35.0	862.5		6.0	1023.4		46.0	1178.6		86.0	1331.8		126.0	1483.3
-34.0	866.5		7.0	1027.3		47.0	1182.4		87.0	1335.7		127.0	1487.0
-33.0	870.4		8.0	1031.2		48.0	1186.3		88.0	1339.5		128.0	1490.8
-32.0	874.3		9.0	1035.1		49.0	1190.1		89.0	1343.3		129.0	1494.6
-31.0	878.3		10.0	1039.0		50.0	1194.0		90.0	1347.1		130.0	1498.3
-30.0	882.2		11.0	1042.9		51.0	1197.8		91.0	1350.9		131.0	1502.1
-29.0	886.2		12.0	1046.8		52.0	1201.7		92.0	1354.7		132.0	1505.6
-28.0	890.1		13.0	1050.7		53.0	1205.5		93.0	1358.4		133.0	1509.6
-27.0	894.1		14.0	1054.5		54.0	1209.4		94.0	1362.3		134.0	1513.3
-26.0	898.0		15.0	1058.5		55.0	1213.2		95.0	1366.1		135.0	1517.1
-25.0	901.9		16.0	1062.4		56.0	1217.1		96.0	1369.9		136.0	1520.9
-24.0	905.6		17.0	1066.3		57.0	1220.9		97.0	1373.7		137.0	1524.6

°C	Ω		°C	Ω		°C	Ω		°C	Ω		°C	Ω
-23.0	909.8		18.0	1070.2		58.0	1224.7		98.0	1377.5		138.0	1528.4
-22.0	913.7		19.0	1074.1		59.0	1228.6		99.0	1381.3		139.0	1532.1
-21.0	917.7		20.0	1077.9		60.0	1232.4		100.0	1385.0		140.0	1535.8
-20.0	921.6		21.0	1081.8		61.0	1236.3		101.0	1388.9		141.0	1539.6
-19.0	925.5		22.0	1085.7		62.0	1240.1		102.0	1392.6		142.0	1543.3
-18.0	929.9		23.0	1089.6		63.0	1243.9		103.0	1396.4		143.0	1547.1
-17.0	933.4		24.0	1093.5		64.0	1247.8		104.0	1400.2		144.0	1550.8
-16.0	937.3		25.0	1097.4		65.0	1251.6		105.0	1404.0		145.0	1554.6
-15.0	941.3		26.0	1101.2		66.0	1255.4		106.0	1407.8		146.0	1558.3
-14.0	945.2		27.0	1105.1		67.0	1259.3		107.0	1411.6		147.0	1562.0
-13.0	949.1		28.0	1109.0		68.0	1263.1		108.0	1415.4		148.0	1565.8
-12.0	953.0		29.0	1112.9		69.0	1266.9		109.0	1419.1		149.0	1569.5
-11.0	956.9		30.0	1116.7		70.0	1270.8		110.0	1422.9		150.0	1573.1
-10.0	960.9		31.0	1120.6		71.0	1274.6		111.0	1426.7			
-9.0	964.8		32.0	1124.5		72.0	1278.4		112.0	1430.5			
-8.0	968.7		33.0	1128.4		73.0	1282.2		113.0	1434.3			
-7.0	972.6		34.0	1132.2		74.0	1286.0		114.0	1438.0			
-6.0	976.5		35.0	1136.1		75.0	1289.9		115.0	1441.8			
-5.0	980.4		36.0	1140.0		76.0	1293.7		116.0	1445.6			
-4.0	984.4		37.0	1143.8		77.0	1297.5		117.0	1449.4			
-3.0	988.3		38.0	1147.7		78.0	1301.3		118.0	1453.1			
-2.0	992.2		39.0	1151.6		79.0	1305.2		119.0	1456.9			
-1.0	996.1		40.0	1155.4		80.0	1309.0		120.0	1460.6			
0.0	1000.0												

8.3 Sensor measurement ranges

Designation	Brief description	Sensor type	Measurement range
Outside sensor	AF	NTC 20	-50 °C to 90 °C
Heat generator sensor	KF	NTC 20	-50 °C to 120 °C
Flow sensor 1	VF1	NTC 20	-50 °C to 120 °C
Flow sensor 2	VF2	NTC 20	-50 °C to 120 °C
Tank sensor	SF	NTC 20	-50 °C to 120 °C
Collector flow sensor	KVLF	PT 1000	-50 °C to 210 °C
Collector tank/buffer sensor	KSPF	NTC 20	-50 °C to 120 °C
Variable input VI-1*)	VE1	NTC 20 PT 1000	-50 °C to 120 °C -50 °C to 500 °C
Variable input VI-2	VE2	NTC 20	-50 °C to 120 °C
Variable input VI-3	VE3	NTC 20	-50 °C to 120 °C

*) Depending on the selection of the assigned function.
PT 1000 e.g. for exhaust gas sensor connection.

8.4 Digital inputs

Designation	Brief description	Input type	Measurement range
Impulse metering unit	Imp	Extra-low voltage	≤ 10 Hz
Burner stage 1 operating hour counter	BZ1	230 V	OFF, ON
Burner stage 2 operating hour counter	BZ2	230 V	OFF, ON

9 Log

Weekly switching program

Object:		Set by:				On:			
Mon (1)	Cont. circuit								
	Time								
	Setpoint								
	Opt.								
Tue (2)	Cont. circuit								
	Time								
	Setpoint								
	Opt.								
Wed (3)	Cont. circuit								
	Time								
	Setpoint								
	Opt.								
Thu (4)	Cont. circuit								
	Time								
	Setpoint								
	Opt.								
Fri (5)	Cont. circuit								
	Time								
	Setpoint								
	Opt.								
Sat (6)	Cont. circuit								
	Time								
	Setpoint								
	Opt.								
Sun (7)	Cont. circuit								
	Time								
	Setpoint								
	Opt.								

Index

B

- Boiler circuit pump, 157
- Boiler circuit pump extended running time, 158
- Boiler circuit pump pre-running time, 158
- Boiler sensor 2, 140
- Boiler temperature offset, 190
- Buffer
 - Discharge protection, 211
 - Forced dissipation, 209
 - Minimum temperature limit, 208
 - Sensor 2, 211
 - Setpoint temperature, 208
 - Siphon function, 210
 - Start-up protection, 210
 - Stratified loading, 211
 - Switching differential, 209
 - Temperature offset of heat generator, 209
- Buffer tank
 - Function, 199
 - Maximum temperature limit, 208
- Building type, 120
- Burner counter mode, 142
- Bus address, 221
- Bypass pump, 159

C

- Cascading, 233
- Charging pump, 156
- Circulation pump, 193
- Circulation pump, 154
- Climate zone, 122
- Collector maximum temperature limit, 196

- Conditional priority, 188
- Constant temperature control, 167
- Cooling switch-over, 176
- Cycle operation, 125

D

- Delay, enabling, full load in cascade operation, 237
- Demand contact, 219
- Design temperature, 122
- District heating control, 155
- District heating valve, 144

E

- Economy interval, 193
- Electrical heating element, 194
- Electromagnetic compatibility, 15
- Emission measurement, 240
- Enabling mode stage II, 134
- Exhaust gas temperature monitoring, 141
- Extended running time CHP, 156
- External switching modem, 218

F

- Fixed-value control, 168
- Flue gas temperature limit, 142
- Forced discharge, 141

G

- Global fault message output, 217
- Grouping for base and peak loads, 238

H

- Heat exchanger valve, 145
- Heat generator
 - Cycle disable, 213
- Heat generator

- Fault, 126
 - Maximum temperature limit, 130
 - Minimum temperature limit, 129
 - Reset, 135
 - Sensor control mode, 130
 - Start-up protection, 128
 - Heating circuit bus authorisation, 233
 - Heating circuit name, 179
 - Heating circuit pump extended running time, 164
 - Heating circuits minimum temperature limit, 130
 - Heating curve, 160, 161
 - Heating limit, 174
 - Heating system, 163
 - Hot water
 - Circuit switching differential, 190
 - Control mode, 153, 188
 - Maximum temperature, 188
 - Night-time temperature, 187
 - Pre-control, 150
 - Pre-regulator, 149
 - Quick connection in cascaded systems, 191
 - Hot-water
 - Control, 151
 - Production, 186
 - Hot-water loading mode stage II, 134
 - Hot-water tank
 - Loading, 186
 - Hydraulic buffer relief, 215
- I**
- Indirect return increase, 160, 222
- L**
- Legionella protection, 187
 - Loading enabling, 190
 - Loading pump extended running, 191
- M**
- Menu
 - Direct Heating Circuit, 170, 179
 - Mixed Heating Circuit, 179
 - Mixed Heating Circuits, 170
 - Minimum burner runtime, 131
- O**
- OpenTherm, 139
 - Operating mode, 118
 - Operating states, 40
 - Operation with NTC 20K room temperature sensor, 232
 - Outside temperature, 121, 122, 135
 - Outside temperature emergency operation value, 121
 - Outside temperature sensing, 120
 - Overview of the technician parameters, 81, 119, 135
- P**
- Parallel operation, 154, 188
 - Parallel operation based on weather conditions, 189
 - Primary pump, 157
 - Extended running time, 157
 - Priority isolating circuit, 189
 - Priority mode, 188
 - Pump forced operation, 127
- R**
- Reduced operation, 163
 - Relay/function test, 241
 - Reset, 77, 251
 - Return increase, 158

- Return interval, 155
 - Return temperature, 146, 148
 - Room connection, 168
 - Room factor, 169
 - Room frost protection limit, 176
 - Room influence, 168
 - Room sensor, 168, 169
 - Room setpoint ramp, 174
 - Room thermostat function, 180
- S**
- Screed function, 164
 - Selection level, 48, 54, 59, 61, 71
 - Selection of parameter presettings, 119
 - Sensor calibration, 251
 - Solar
 - Anti-blocking protection, 199
 - Collector maximum temperature limit, 196
 - Function, 196
 - Heat balancing, 198
 - Heat capacity, 199
 - Heat generator cycle disable, 197
 - Minimum runtime of loading pump SOP, 196
 - Priority mode, 197
 - Priority/parallel switch-over, 198
 - Resetting heat balancing, 198, 199
 - Switch-off differential, 196
 - Switch-on differential, 196
 - Tank maximum temperature limit, 197
 - Solid fuel
 - Function, 212
 - Solid fuel
 - Minimum temperature, 212
 - Solid fuel
 - Maximum temperature, 213
 - Solid fuel
 - Switch-on differential, 213
 - Solid fuel
 - Switch-off differential, 213
 - Solid fuel
 - Anti-blocking protection of solid-fuel pump, 213
 - Summer switch-off, 123
 - Switching differential I, 132
 - Switching differential II, 132
 - Switching times, 73
 - Switch-off optimisation, 170
 - Switch-on optimisation, 170, 172, 173
 - System frost protection, 124
- T**
- Tank discharge protection, 190
 - Tank loading switch-over, 213
 - Tank sensor 2, 191
 - Temperature displays, 37
 - Temperature limit, 163
 - Temperature measurement, 187
 - Temperature offset, 164
 - Time delay stage II, 134
 - Timer, 217
 - Total flow sensor, 225
- V**
- Variable inputs and outputs, 115, 119

Honeywell

Manufactured for and on behalf of the Environmental and Energy Solutions Division of Honeywell Technologies Sàrl,
Rolle, Z.A. La Pièce 16, Switzerland by its Authorized Representative:

Automation and Control Solutions

Honeywell House
Arlington Business Park
Bracknell, Berks, RG12 1EB
Phone(44) 1344 656000
Fax (44) 1344 656644
<http://honeywell.com/uk>

Printed in Germany
All rights reserved. Subject to change without notice.
EN2H-0221GE51 R0318